

# CLS

## User's Guide

### **Watlow Controls**

1241 Bundy Blvd.  
Winona, MN 55987

#### **Customer Service**

Phone: (800) 414-4299  
Fax: (800) 445-8992

#### **Technical Support**

Phone: (507) 494-5656  
Fax: (507) 452-4507  
Email: [wintechsupport@watlow.com](mailto:wintechsupport@watlow.com)

Part No. 21952-00. Revision 3.2  
October 1996

**Copyright © 1996**  
**Watlow Anafaze**

Information in this manual is subject to change without notice. No part of this publication may be reproduced, stored in a retrieval system, or transmitted in any form without written permission from Watlow Anafaze.

## Warranty

Watlow Anafaze, Incorporated warrants that the products furnished under this Agreement will be free from defects in material and workmanship for a period of three years from the date of shipment. The Customer shall provide notice of any defect to Watlow Anafaze, Incorporated within one week after the Customer's discovery of such defect. The sole obligation and liability of Watlow Anafaze, Incorporated under this warranty shall be to repair or replace, at its option and without cost to the Customer, the defective product or part.

Upon request by Watlow Anafaze, Incorporated, the product or part claimed to be defective shall immediately be returned at the Customer's expense to Watlow Anafaze, Incorporated. Replaced or repaired products or parts will be shipped to the Customer at the expense of Watlow Anafaze, Incorporated.

There shall be no warranty or liability for any products or parts that have been subject to misuse, accident, negligence, failure of electric power or modification by the Customer without the written approval of Watlow Anafaze, Incorporated. Final determination of warranty eligibility shall be made by Watlow Anafaze, Incorporated. If a warranty claim is considered invalid for any reason, the Customer will be charged for services performed and expenses incurred by Watlow Anafaze, Incorporated in handling and shipping the returned unit.

If replacement parts are supplied or repairs made during the original warranty period, the warranty period for the replacement or repaired part shall terminate with the termination of the warranty period of the original product or part.

The foregoing warranty constitutes the sole liability of Watlow Anafaze, Incorporated and the Customer's sole remedy with respect to the products. It is in lieu of all other warranties, liabilities, and remedies. Except as thus provided, Watlow Anafaze, Inc. disclaims all warranties, express or implied, including any warranty of merchantability or fitness for a particular purpose.

**Please Note:** External safety devices must be used with this equipment.

# Contents

<b>Overview</b>	<b>1</b>
System Diagram.....	2
Parts List .....	2
Safety .....	3
<b>Introduction</b>	<b>5</b>
Specifications .....	7
Analog Inputs .....	7
Digital Inputs .....	9
User-Selectable Digital Outputs .....	9
System Digital Outputs.....	9
Analog Outputs .....	10
Miscellaneous Specifications .....	11
Physical Dimensions .....	11
<b>Installation</b>	<b>13</b>
Precautions and Warnings .....	14
Recommended Tools .....	15
Panel Hole Cutters .....	15
Other Tools .....	15
CLS Mounting Procedure .....	16
Mounting Environment .....	16
Steps: .....	16
TB-18 Mounting Instructions .....	17
TB-50 Mounting Instructions .....	18
General Wiring Recommendations .....	20
Grounding .....	21
Thermocouple Wiring .....	22
Input Wiring .....	22
Output Wiring .....	23
Communications Wiring .....	23
Wiring: Noise Suppression .....	24
General Wiring .....	25
Power Wiring and Controller Test .....	25
Outputs .....	27
PID Control and Alarm Output Connections 2.....	30
Watchdog Timer .....	30
TB-18 Connections .....	31
TB-50 Connections .....	32

Inputs .....	34
Input Scaling .....	34
4 and 8 CLS Scaling Values .....	35
16 CLS Scaling Values .....	38
Scaling and Calibration .....	39
T/C Inputs .....	39
RTD Inputs (4 and 8 CLS only) .....	40
Current Inputs .....	41
Voltage Inputs .....	41
Unused Inputs .....	41
Back Terminal Block Connections .....	42
Serial Communications .....	42
RS-232 Interface .....	43
RS-485 Interface .....	43
<b><i>Using the CLS</i></b> .....	<b>49</b>
Introduction .....	49
Front Panel .....	50
Front Panel Keys .....	50
Displays .....	53
Bar Graph Display .....	53
Single Loop Display .....	54
Alarms .....	56
Job Display .....	57
Operator Menus .....	58
Change Setpoint .....	58
Manual/Automatic Control .....	58
Ramp/Soak .....	60
<b><i>Setup</i></b> .....	<b>61</b>
How to Enter the Setup Menus? .....	61
How to edit a menu? .....	61
Set up Global Parameters Menu .....	63
Load a Job .....	64
Save Setup to Job .....	64
Job Select Inputs .....	65
Job Select Input Polarity .....	65
Output Override Digital Input .....	66
Output Override Input Polarity .....	66
Start-up Alarm Delay .....	66
Keyboard Lock Status .....	67
Power-Up Output Status .....	67
Controller Address .....	67
Communications Baud Rate .....	68

Communications Protocol .....	68
Communications Error Checking .....	68
AC Line Frequency .....	69
Digital Output Polarity .....	69
EPROM Information .....	69
Set up Loop Input .....	70
Input Type .....	71
Pulse Sample Time .....	72
Loop Name .....	72
Input Units .....	72
Input Reading Offset .....	73
Linear Scaling Menus .....	73
Display Format .....	75
High Process Value .....	75
High Reading .....	76
Low Process Value .....	76
Low Reading .....	76
Input Filter .....	77
Set up Loop Control Parameters .....	78
Heat or Cool Control PB .....	79
Heat or Cool Control TI .....	79
Heat or Cool Control TD .....	79
Heat or Cool Output Filter .....	80
Heat and Cool Spread .....	80
Set up Loop Outputs .....	81
Enable/Disable Heat or Cool Outputs .....	82
Heat or Cool Output Type .....	82
Heat or Cool Cycle Time .....	83
SDAC Menus .....	83
SDAC Mode .....	83
SDAC High Value .....	84
SDAC Low Value .....	84
Heat or Cool Output Action .....	84
Heat or Cool Output Limit .....	85
Heat or Cool Output Limit Time .....	85
Heat or Cool Output Override .....	85
Heat or Cool Nonlinear Output Curve .....	86
Set up Loop Alarms .....	87
Alarm Types .....	87
High Process Alarm Setpoint .....	90
High Process Alarm Type .....	90
High Process Alarm Output Number .....	90
Deviation Band Value .....	91
High Deviation Alarm Type .....	91

High Deviation Alarm Output Number .....	91
Low Deviation Alarm Type .....	92
Low Deviation Alarm Output Number .....	92
Low Process Alarm Setpoint .....	92
Low Process Alarm Type .....	93
Low Process Alarm Output Number .....	93
Alarm Deadband .....	93
Alarm Delay .....	94
Manual I/O Test .....	95
Digital Input Testing .....	95
Test Digital Output .....	96
Toggle Digital Output .....	96
Keypad Test .....	96
<b><i>PID Tuning and Control</i></b> .....	<b>97</b>
Introduction .....	97
Control Modes .....	98
On/Off Control .....	98
Proportional Control .....	98
Proportional and Integral Control .....	99
Proportional, Integral and Derivative Control .....	100
Control Outputs .....	100
Digital Output Control Forms .....	100
Setting Up and Tuning PID Loops .....	103
Proportional Band (PB) Settings .....	103
Integral Term (TI) Settings .....	104
Derivative Term (TD) Settings .....	104
General PID Constants by Application .....	105
Proportional Band Only (P) .....	105
Proportional with Integral (PI) .....	105
PI with Derivative (PID) .....	105
<b><i>Troubleshooting</i></b> .....	<b>107</b>
No Key Reset .....	107
Returning your Unit .....	108
Troubleshooting Stand-Alone Systems .....	108
Checking an Analog Input .....	108
Checking Digital I/O .....	109
Checking Computer Supervised Systems .....	110
Computer Problems .....	110
Software Problems .....	111
Changing the EPROM .....	111

<b><i>Linear Scaling Examples</i></b>	<b><i>115</i></b>
Example 1 .....	115
Example 2 .....	116
Example 3 .....	117
<b><i>Appendix A: Ramp Soak</i></b>	<b><i>119</i></b>
Introduction .....	119
R/S Features .....	119
Specifications .....	120
Configuring Ramp/Soak .....	120
Setting the R/S Time Base .....	121
Editing R/S Parameters .....	121
Choosing a Profile to Edit .....	121
Copying the Setup from Another Profile .....	122
Editing the tolerance Alarm Time .....	122
Editing the Ready Setpoint .....	123
Editing the Ready Event States .....	123
Choosing an External Reset Input .....	124
Editing a Segment .....	124
Setting Segment Time .....	124
Setting a Segment Setpoint .....	125
Configuring Segment Events .....	125
Editing Event Outputs .....	126
Changing Event States .....	126
Editing Segment Triggers .....	126
Assigning an Input to a Trigger .....	127
Changing a Trigger's True State .....	127
Latching or Unlatching a Trigger .....	127
Setting Segment Tolerance .....	128
Ending a Profile .....	128
Repeating a Profile .....	128
Using Ramp/Soak .....	129
Assigning a profile to a loop .....	129
Assigning a Profile to a Linear Input Loop .....	130
Running a Profile .....	131
Ramp/Soak Displays .....	131
Holding a Profile or Continuing from Hold .....	134
Resetting a profile .....	135
<b><i>Appendix B: Enhanced Process Control</i></b>	<b><i>137</i></b>
Enhanced Process Control Menus .....	138

---

Process Variable Retransmit .....	139
Setting Up a PV Retransmit .....	139
PV Retransmit Menus .....	140
Cascade Control .....	143
Setting Up Cascade Control .....	143
Cascade Control Menus .....	144
Ratio control .....	147
Setting Up Ratio Control .....	147
Ratio Control Menus .....	148
Remote Analog setpoint .....	149
Differential Control .....	149
Typical Applications .....	150
Process Variable Retransmit .....	150
Cascade Control .....	153
Ratio Control .....	156
Remote Setpoint .....	158
Differential Control .....	159

***Glossary******163***

# Overview

This manual describes how to install, setup, and operate a 4CLS, an 8CLS, or a 16CLS. Included are seven chapters, two Appendices, and a glossary of terms. Each chapter covers a different aspect of your control system and may apply to different users. The following describes the chapters and their purpose.

- **Introduction:** Gives a general description of the CLS and its related specifications.
- **Installation:** Describes how to install the CLS and its peripheral devices.
- **Using the CLS:** Provides an overview of operator displays used for system monitoring.
- **Setup:** Describes all the setup displays for the controller, and how to access them.
- **Tuning and Control:** Explains PID control and provides tips for tuning your system.
- **Troubleshooting:** Gives some basic guidelines for solving control problems.
- **Linear Scaling Examples:** Provides an example configuring a pressure sensor, and one configuring a flow sensor.
- **Appendix A: Ramp and Soak.** This section explains how to setup and use Ramp/Soak profiles in your application.
- **Appendix B:** Enhanced Process Control. This appendix describes optional process variable retransmit and cascade control features.

---

## System Diagram

The illustration below shows how the parts of the CLS are connected. When unpacking your system, use the diagrams and parts list below to ensure all parts have been shipped. Please don't hesitate to call Watlow Anafaze's Technical Service Department if you have problems with your shipment, or if the CLS components are missing or damaged.

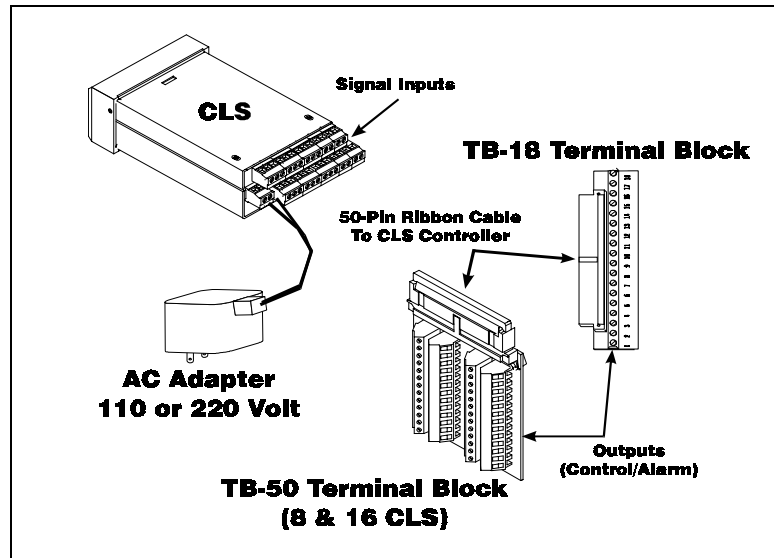

---

## Parts List

- CLS controller
- Controller mount kit
- AC adapter (110V or 220V)
- Terminal Block (TB-50 or TB-18)
- TB-50 or TB-18 mounting kit
- 50 pin flat ribbon cable (50 pin ribbon cable)
- DAC or SDAC (optional)
- User Manual

## Safety

---

Watlow Anafaze has made efforts to ensure the reliability and safety of the CLS Controller and to recommend safe usage practices in systems applications. Please note that, in any application, failures can occur. These failures may result in full control outputs or other outputs which may cause damage to or unsafe conditions in the equipment or process connected to the CLS Controller.

Good engineering practices, electrical codes, and insurance regulations require that you use independent external safety devices to prevent potentially dangerous or unsafe conditions. Assume that the Watlow Anafaze CLS Controller can fail with outputs full on, outputs full off, or that other unexpected conditions can occur.

Install high or low temperature protection in systems where an overtemperature or undertemperature fault condition could present a fire hazard or other hazard. Failure to install temperature control protection where a potential hazard exists could result in damage to equipment and property, and injury to personnel.

The CLS includes a reset circuit that sets the control outputs off or to the data stored in memory if the microprocessor resets--normally the result of a power failure and power return. If a memory-based restart will be unsafe for your process, program the CLS Controller to restart with outputs off. For additional safety, program the computer or other host device to automatically reload the desired operating constants or process values on return of operating power. However, these safety features do not eliminate the need for external, independent safety devices in potentially dangerous or unsafe conditions.

Watlow Anafaze also offers ANASOFT<sup>®</sup>, an optional software program for IBM-AT<sup>®</sup> or IBM-PC<sup>®</sup> compatible computers. In the event of a reset, ANASOFT will reload the CLS Controller with the current values in computer memory. The user must ensure that this reset will be safe for the process. Again, use of ANASOFT does not eliminate the need for appropriate external, independent safety devices.

Contact Watlow Anafaze immediately if you have any questions about system safety or system operation.



# Introduction

The CLS is a modular control system with up to 16 fully independent loops of PID control (16 CLS). It functions as a stand-alone controller; the CLS 1/8 DIN front panel has a Liquid Crystal Display (LCD) and touch keypad for local display and local parameter entry. You can also use it as the key element in a computer-supervised data acquisition and control system; the CLS can be locally or remotely controlled via an RS-232 or RS-485 serial communications interface.

The CLS features include:

**Direct Connection of Mixed Thermocouple Sensors:** Directly connect most thermocouples with the CLS versatile hardware. Thermocouple inputs feature reference junction compensation, linearization, PV offset calibration to correct for sensor inaccuracies, T/C upscale break detection, and a choice of Fahrenheit or Celsius display.

**Resistive Temperature Detector Sensors are Standard Inputs:** Two types of standard three wire 100 ohm platinum DIN curve sensor are standard inputs for the CLS. (To use this input, order the CLS with scaling resistors.)

**Automatic Scaling for Linear Analog Inputs:** The CLS automatically scales linear inputs used with other industrial process sensors. Simply enter two measurement points. For example, to scale a PSI sensor enter the endpoints: Low PV is 10 PSI, while High PV is 100 PSI. All other values for that loop will automatically be in PSI.

**Dual Outputs Standard:** The CLS includes dual control outputs for each loop, with independent control constants for each output.

**Independently Selectable PID Output Modes:** You can set each control output to ON/OFF, Time Proportioning, Serial DAC, or Distributed Zero Crossing mode. You can set each output control mode for ON/OFF, P, PI, or PID control with reverse or direct action.

**Flexible Alarm Outputs:** Independently set high/low process alarms and a high/low deviation band alarm for each loop. Alarms can activate a digital output by themselves, or they can be grouped with other alarms to activate an output.

**Alarm or Control Outputs:** You can set high/low deviation and high/low process setpoints to operate digital outputs as on/off control functions instead of alarms. (The control function has no alarm notification or global alarm output.)

**Global Alarm Output:** When any alarm is triggered, the Global Alarm Output is also triggered, and it stays on until you acknowledge it.

**Watchdog Timer:** The CLS watchdog timer output notifies you of system failure. You can use it to hold a relay closed while the controller is running, so you are notified if the microprocessor shuts down.

**Front Panel or Computer Operation:** Set up and run the CLS from the front panel or from a local or remote computer. Watlow Anafaze offers ANASOFT, our IBM AT or IBM-PC compatible software you can use to operate the CLS. ANASOFT has these features:

- Process Overviews
- Parameter Setup
- Graphic Trend Plotting
- Data Logging

**Multiple Job Storage:** Store up to 8 jobs in protected memory, and access them locally by entering a single job number or remotely via digital inputs. Each job is a set of operating conditions, including setpoints and alarms.

**Non-Linear Output Curves Standard:** Select either of two non-linear output curves for each control output.

**Autotuning Makes Setup Simple:** Use the Autotune feature to set up your system quickly and easily. The CLS internal expert system table finds the correct PID parameters for your process.

**Pulse Counter Input Standard:** Use the pulse counter input for precise control of motor or belt speed.

## Specifications

---

The following section contains specifications for inputs, outputs, the serial interface, system power requirements, environmental specifications, and the CLS physical dimensions.

### Analog Inputs

**Number of Control Loops:** 4 (4CLS), 8 (8CLS), 16 (16CLS), plus one pulse loop.

**Number of Analog Inputs:** 4 (4CLS), 8 (8CLS), 16 (16CLS).

**Input Switching:** differential solid state MUX switching.

**Input Sampling Rate:**

4CLS: 6x/sec (167 ms) at 60 Hz; 5x/sec (200 ms) at 50 Hz.

8CLS: 3x/sec (333 ms) at 60 Hz; 2.5x/sec (400 ms) at 50 Hz.

16CLS: 1.5x/sec (667 ms) at 60 Hz; 1.25x/sec (300 ms) at 50 Hz.

**Analog Over Voltage Protection:**  $\pm 20$  V referenced to digital ground.

**Common Mode Rejection (CMR):** For inputs that don't exceed  $\pm 5$  V, >60 dB DC to 1 kHz, and 120 dB at selected line frequency.

**A/D Converter:** Integrates voltage to frequency.

**Input Range:** -10 to +60 mV. Other ranges are available with scaling resistors.

**Resolution:** 0.006%, greater than 14 bits. (This is the internal measurement resolution, not the display resolution.)

**Calibration:** Automatic zero and full scale.

**Thermocouple Ranges and Resolution:**

T/C Type	Range in °F	Range in °C	* Accuracy: 25°C Ambient		* Accuracy: 0-50°C Full Temp. Range	
			°C	°F	°C	°F
J T/C	-350 to 1400	-212 to 760	±0.5	±0.9	±1.1	±2.0
K T/C	-450 to 2500	-268 to 1371	±0.6	±1.2	±1.35	±2.7
T T/C	-450 to 750	-268 to 399	±1.3	±2.4	±2.9	±5.4
S T/C	0 to 3200	-18 to 1760	±2.5	±4.5	±5.6	±10.1
R T/C	0 to 3210	-18 to 1766	±2.5	±4.5	±5.6	±10.1
B T/C	150 to 3200	66 to 1760	±6.6	±12.0	±14.9	±27.0
E T/C	-328 to 1448	-200 to 787				

\* True for 10% to 100% of span.

**RTD Ranges and Resolution (4 and 8 CLS only):**

Name	Range in °F	Range in °C	Resolution	Measurement Temp. In °C	Accuracy: 25°C Ambient		Accuracy: 0-50°C Ambient	
					°C	°F	°C	°F
RTD1	-148.0 to 527.0	-100.0 to 275.0	0.023 °C	25	±0.35	±0.63	±0.5	±0.9
				275	±1	±1.8	±1.5	±2.7
RTD2	-184 to 1544	-120 to 840	0.062 °C	25	±0.9	±1.62	±2.8	±5.04
				840	±1.1	±1.98	±4.3	±7.74

**T/C Break Detection: Pulse type for upscale break detection.**

**Milliamp inputs:** 0-20 mA (3 ohms resistance) or 0-10 mA (6 ohms resistance), with scaling resistors.

**Voltage inputs:** 0-12V, 0-10V, 0-5V, 0-1V, 0-500mV, 0-100 mV with scaling resistors.

Range	Input Resistance
0-12 V	85 Kohms
0-10 V	50 Kohms
0-5 V	40 Kohms
0-1 V	7.4 Kohms
0-500 mV	6.2 Kohms
0-100 mV	1.2 Kohms

Source Impedance: For 60 mV T/C, measurements are within specification with up to 500 ohms source resistance.

## Digital Inputs

**Number:** 8

**Configuration:** 8 selectable for output override, remote job selection.

**Input Voltage Protection:** Diodes to supply and common. Source must limit to 10 mA for override conditions.

**Voltage Levels:** <1.3V=Low; >3.7V=High (TTL).

**Maximum Switch Resistance to Pull Input Low:** 1 Kohms.

**Minimum Switch Off Resistance:** 11 Kohms.

## User-Selectable Digital Outputs

**Number:** 34

**Operation:** Open collector output; On state sinks to logic common. Current  $\leq 20$  mA for 35 loads. Single load  $\leq 40$  mA. I total  $\leq 700$  mA.

**Function:** Selectable as PID control or alarm/control.

**Number of PID Control Outputs per PID Loop:** 2 (max)

**PID Control Output Types:** Time Proportioning, Distributed Zero Crossing, SDAC, or On/Off—all independently selectable for each output. Heat and cool control outputs can be individually disabled for use as alarm outputs.

**Time Proportioning Cycle Time:** 1-255 seconds, programmable for each output.

**PID Control Action:** Reverse (heat) or direct (cool), independently selectable for each output.

**Off State Leakage Current:** <.01 mA to DC common.

## System Digital Outputs

**System Digital Outputs:** 1 Global Alarm, 1 CPU watchdog.

**Operation:** Open collector output; On state sinks to logic common. Current  $\leq 20$  mA for 35 loads. Single load  $\leq 40$  mA. I total  $\leq 700$  mA.

## Analog Outputs

The Watlow Anafaze Digital to Analog Converter (DAC) is an optional module for the CLS. It lets you convert a Distributed Zero Crossing control output signal to an analog process control signal. You can purchase a 4-20 mA<sub>dc</sub>, 0-5 V<sub>dc</sub>, and 0-10 V<sub>dc</sub> versions of the DAC.

Watlow Anafaze also offers the Serial DAC for precision open-loop control. 0-5 V<sub>dc</sub>/4-20 mA<sub>dc</sub> jumper selectable.

Contact Watlow Anafaze for more information about the DAC and Serial DAC.

---

## Miscellaneous Specifications

### *Serial Interface*

**Type:** RS-232 3 wire or RS-485 4 wire.

**Isolation:**

RS-232 None

RS-485 To EIA RS-485 Specification.

**Baud Rate:** 2400 or 9600, user selectable.

**Error Check:** BCC or CRC, user selectable.

**Number of Controllers:** 1 with RS-232 communications;

32 with RS-485 communications.

**Protocol:** Form of ANSI X3.28-1976 (D1, F1), compatible with Allen Bradley PLC, full duplex.

### *System Power Requirements*

**Voltage:** 12-24 Vdc

**Input Current (no load):** 300 mA max

**Maximum Current Requirement:** 610 mA. (If the reference voltage is externally loaded, add 1 mA supply current for every 1 mA of load up to a maximum load of 100 mA. If using the +5V logic supply to power digital outputs, add 0.6 mA supply current for every 1 mA of load up to a maximum load of 350 mA. Therefore, the maximum current requirement is  $300 + 100 + (0.6 \times 350) = 610$  mA.)

### *Environmental Specifications*

**Storage Temperature:** -20 to 60°C

**Operating Temperature:** 0 to 50°C

**Humidity:** 10 to 95% non-condensing.

## Physical Dimensions

**CLS:** 1.75 lbs., 1.98" x 3.78" x 7.10" (.8 kg, 50 mm x 96 mm x 180 mm.)

**TB-18:** 1.025" x 3.700" (2.57 cm x 9.29 cm)

**TB-50:** 3.2" x 3.4" (8.03 cm x 8.53 cm)



# Installation

These installation instructions are written for non-technical users; if you are an electrician or you are technically proficient, they may seem simple to you. Please at least skim all of the instructions, to make sure you don't miss anything vital.

This section explains installation for the CLS only. If you are installing another Watlow Anafaze product (such as an SDAC), see the manual shipped with it to learn how to install it.

These symbols are used throughout the rest of this manual:



---

## DANGER

**This symbol warns you about hazards to human life.**

---



---

## WARNING

**This symbol warns you of possible damage to property or equipment.**

---



---

## NOTE

**This symbol denotes information you must know in order to proceed.**

---

---

## Precautions and Warnings

---



---

### DANGER

Shut off power to your process before you install the CLS. High voltage may be present even when power is turned off! Reduce the danger of electric shock after installation by mounting the CLS in an enclosure that prevents personal contact with electrical components.

The CLS measures input signals that are not normally referenced to ground, so the CLS inputs and other signal lines can have high voltage present even when power is turned off--for example, if you inadvertently short a thermocouple to the AC power line.



---

### WARNING

During installation and wiring, place temporary covers over the housing slots and the rear of the CLS so dirt, pieces of wire, et cetera don't fall through the slots. Remove these covers after installation.

Install the CLS so the slots in the housing receive unrestricted airflow after installation. Make sure that other equipment does not block airflow to the housing slots.

Use #20 or #22 AWG wires and trim wire insulation to 1/4" (5 mm). Wire should fit inside the terminal with no bare wire exposed, to prevent contact between wires and the grounded case. Tin any stranded wire.

Support power, input and output cables to reduce strain on the terminals and to prevent wire removal.



---

### NOTE

Be sure to select a panel location that leaves enough clearance to install and remove the CLS and its components.

---

---

## Recommended Tools

Use these tools to install the CLS:

### Panel Hole Cutters

Use any of the following tools to cut a hole of the appropriate size in the panel.

- Jigsaw and metal file--for stainless steel and heavyweight panel doors.
- Greenlee 1/8 DIN rectangular punch (Greenlee part # 600-68), for most panel materials and thicknesses.
- Nibbler and metal file--for aluminum and lightweight panel doors.

### Other Tools

You will also need these tools:

- Phillips head screwdriver.
- Flathead screwdriver for wiring.
- Multimeter.

## CLS Mounting Procedure



### NOTE

**Mount the controller before you mount the terminal block or do any wiring. The controller's placement affects placement and wiring considerations for the other components of your system.**

## Mounting Environment

Install the CLS in a location free from excessive ( $>50^{\circ}\text{C}$ ) heat, dust, and unauthorized handling. The controller can mount in any panel material up to 0.2" thick. (Make sure there is enough clearance for mounting brackets and terminal blocks; the controller extends 6.2" behind the panel face and the screw brackets extend 0.5" above and below it.)

## Steps:

1. Cut a hole  $3.630 \pm 0.020$ " long by  $1.800 \pm 0.020$ " tall in the panel. This figure shows the mounting hole. (The figure is not a template.) Cut carefully; the 0.020" (0.5 mm) tolerances don't allow much room for error. Use a punch, nibbler, or jigsaw, and file the edges of the hole.

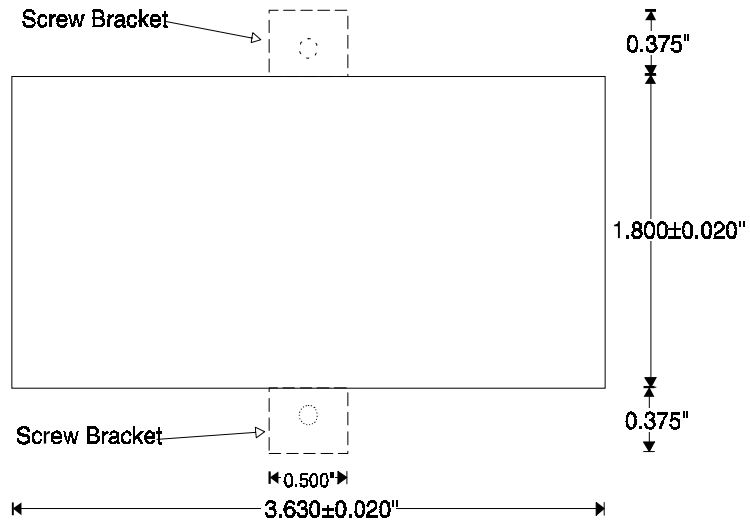

2. Insert the controller into the hole through the front of the panel.
3. Screw the top and bottom clips in place: insert the screw's lip into the cutout in the metal housing just behind the front panel. Tighten the screw.
4. If you expect much panel vibration, use a rear support for the CLS and its interconnecting cables.

---

## TB-18 Mounting Instructions

These steps describe how to mount the TB-18 on the rear of the CLS. (Please follow these steps exactly, so you do not damage either the terminal block or the controller.)

1. Install the cable support on the underside of the CLS. The TB-18 was shipped to you in a plastic bag. The bag also contained a cable tie (the long plastic strip) and a cable tie mount (the square plastic piece with one sticky side).
  - a. Stick the cable tie mount to the underside of the CLS. Install it in a spot that won't block the vents.
  - b. Thread the cable tie through the hole in the cable tie mount. When you're finished wiring the outputs, it should look like this illustration.

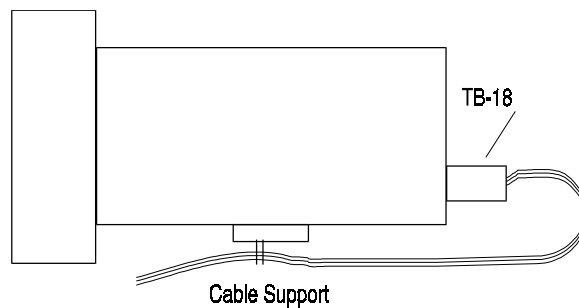

2. Next, wire outputs to the terminal block. (For help, see Wiring Outputs later in this chapter.) Route wires through the cable support, leaving about 9" of wire between the TB-18 and the support.
3. Gently slide the female part of the terminal block into the 50-pin header on the rear of the controller, as shown here.

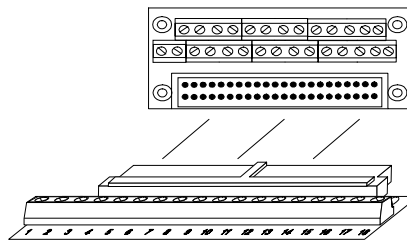

---

### WARNING

**Do not connect power to the CLS now. Test the unit first, as explained in the Power Wiring and Controller Test section.**

---

## TB-50 Mounting Instructions

These steps tell you how to mount the TB-50. (Please follow these steps exactly, so you don't damage the terminal block, the ribbon cable, or the controller.)

1. Choose a mounting location. Be sure there is enough clearance to install and remove the TB-50; it measures 3.4" long X 3.2" wide X 1.27" tall.
2. Watlow Anafaze shipped the TB-50 to you in an antistatic bag. Make sure these parts are also in the bag:
  - Five plastic standoffs.
  - Five 6-32 screws.
  - Five cable tie wraps.
  - One 50-pin ribbon cable.
  - Five ribbon cable clamps.

3. Snap four of the plastic standoffs into the four mounting holes on the TB-50.

There are also four smaller holes on the terminal board, as shown here. These holes are for the cable tie wraps--the plastic standoffs won't fit them. You'll use these holes to secure wiring to the terminal block. (See **Wiring Outputs** in this chapter for help installing cable tie wraps.)

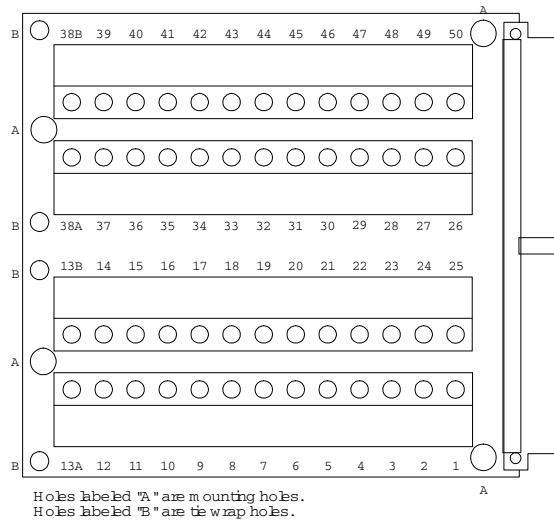

4. Place the TB-50 where you will mount it and use a pencil to trace around the standoffs.
5. Drill and tap #6-32 holes in the locations you marked.
6. Place the TB-50 where you will mount it. Insert the #6 screws in the standoffs and tighten them.



---

**NOTE**

**Save the cable tie wraps, ribbon cable, and ribbon cable clamps. You'll use them when you wire outputs to the TB-50 and when you connect the ribbon cable.**

---



---

**WARNING**

**Do not connect power to the CLS now. Test the unit first, as explained in the *Power Wiring and Controller Test* section.**

---

## General Wiring Recommendations

Use the cables below or their equivalent. For best results, use appropriate materials, proper installation techniques and the correct equipment. For example, choose wire type by function, installation requirements, and the likelihood of mechanical or electrical problems at your installation.

Function	MFR P/N	No. of Wires	AWG
Analog inputs	Belden #9154	2	20
	Belden #8451	2	22
RTD Inputs (4 & 8 CLS)	Belden #8772	3	20
	Belden #9770	3	22
T/C Inputs	T/C Ext. Wire	2	20
Digital PID outputs and Digital I/O	Belden #9539	9	24
	Belden #9542	20	24
	Ribbon Cable	50	
Computer Communication: RS232 or RS485	Belden #9729	4	24
	Belden #9730	6	24
	Belden #9842	4	24
	Belden #9843	6	24



### WARNING

**Never wire bundles of low power controller circuits next to bundles of high power AC wiring. Instead, physically separate high power circuits from the controller. If possible, install high voltage AC power circuits in a separate panel.**

- Use stranded wire. Solid wire is used for fixed service; it makes intermittent connections when you move it for maintenance.
- Use #20 or #22 AWG wire. Larger or smaller sizes may be difficult to install, may break easily, or may cause intermittent connections.
- Use shielded wire. (The electrical shield helps protect the CLS from electrical noise.) Connect one end of the input wiring shield to the CLS panel's 120 Vac panel ground, and connect one end of the output wiring shield to the CLS panel's 120 Vac panel ground. (Some installations may require a different shield configuration. Contact Watlow Anafaze for more information if these instructions do not apply to your system.)

For more noise suppression measures, see **Noise Suppression**.

## Grounding

Connect the CLS chassis to an external ground at only one point, to avoid ground loops that can cause instrument errors or malfunctions. Since the CLS uses a non-isolated measurement system, it has the following connections to power supply common:

- Analog common TB1 pins 5, 6, 11, & 12
- Reference common, TB1 pin 17
- Communications ground (TB1 pins 23 & 24) if using RS-232
- Power supply ground, TB2 pin 2
- Control common (TB-18 pin 2; TB-50 pin 3 and 4)

Watlow Anafaze strongly recommends that you:

- Do not connect any one of these pins to earth ground. Do not tie them together externally.
- Isolate outputs through solid state relays, where possible.
- Isolate RTDs or “bridge” type inputs from ground, if used.
- Isolate digital inputs from ground through solid state relays. If you can't do that, then make sure the digital input is the only place that one of the above pins connects to ground.
- If you are using RS-232 from an un-isolated host, don't connect any other power common point to earth ground.

## Thermocouple Wiring

Use 18 or 20 AWG thermocouple (T/C) extension wire for all the T/C inputs.



---

### NOTE

**Most thermocouple wire is solid unshielded wire. Use shielded wire if required at your installation; ground one end only.**

---



---

### WARNING

**The CLS uses a floating ground system. Therefore:**

**Isolate input devices or host computers connected through communications cables (like RS-232) from earth ground.**

**Use ungrounded thermocouples with the thermocouple sheath electrically connected to earth ground.**

**Use optically isolated RS-232 devices to isolate earth grounded host computers from CLSs.**

**When you use grounded T/Cs, tie the thermocouple shields to a common earth ground in one place. Otherwise any common mode voltages that exceed 5 volts may cause incorrect readings or damage to the controller.**

---



---

### WARNING

**The 16CLS has single ended inputs, offering little protection from common mode voltage sources. Therefore Watlow Anafaze highly recommends that you use ungrounded thermocouples with the external thermocouple sheath electrically connected to earth ground.**

---

You can use 400 to 500' of thermocouple extension wire, depending on wire type and wire size, and keep to accuracy and source impedance specifications. Be sure to install thermocouple wiring in a separate conduit away from AC power (the 120 Vac control supply) and high power (240 Vac or higher) wiring.

## Input Wiring

Use multicolored stranded shielded cable for analog inputs. Watlow Anafaze recommends that you use #20 AWG wire. (If the sensor manufacturer requires it, you can also use #22 or #24 AWG wiring.) Most inputs use a shielded twisted pair; some require a 3 wire input.

## Output Wiring

Use multicolored stranded shielded cable for analog outputs (if you have installed an SDAC) and PID digital outputs connected to panel mount SSRs. Analog outputs generally use a twisted pair, while digital outputs have 9-20 conductors, depending on wiring technique.

For instructions on using the cable tie wraps included in the TB-50's packaging, see the *Wiring Outputs* section.

## Communications Wiring

Large systems can pull in an extra pair to the computer communications wiring. The extra pair services a sound power phone system for communications between the Watlow Anafaze controller and a computer.

If you choose this option for maintenance, calibration checking, et cetera, Watlow Anafaze recommends a David Clark #H5030 system.

---

## Wiring: Noise Suppression

If the CLS's outputs control dry contact electromechanical relays with inductive loads--like alarm horns and motor starters--you may get Electro-magnetic Interference (EMI, or "noise") The following section explains how to avoid noise problems; read it before you wire the CLS.

### *Symptoms of RFI/EMI*

If your controller displays the following symptoms, suspect EMI.

- The CLS's display blanks out and then reenergizes as if power had been turned off for a moment.
- The process value does not display correctly.

EMI may also damage the digital output circuit--so digital outputs will not energize. If the digital output circuit is damaged, return the controller to Watlow Anafaze for repair.

### *Avoiding Noise Problems*

To avoid noise problems:

Where possible, use solid state relays (SSRs) instead of electromechanical (EM) relays. If you must use EM relays, try to avoid mounting them in the same panel as the CLS equipment.

Separate the 120 Vac power leads from the low level input and output leads connected to the CLS. Don't run the digital output or PID control output leads in bundles with 120 Vac wires. (Never run input leads in bundles with high power leads. See the General Wiring section.)

If you must use EM relays and you must place them in a panel with CLS equipment, use a .01 microfarad capacitor rated at 1000 Vac (or higher) in series with a 47 ohm, 1/2 watt resistor across the NO contacts of the relay load. This network is known as an arc suppressor or snubber network.

You can use other voltage suppression devices, but they are not usually required. For instance, you can place a metal oxide varistor (MOV) rated at 130 Vac for 120 Vac control circuits across the load, which limits the peak AC voltage to about 180 Vac (Watlow Anafaze P/N 26-130210-00). You can also place a transorb (back to back zener diodes) across the digital output, which limits the digital output loop to 5 Vdc. (All the parts mentioned here are available from Watlow Anafaze).

The above steps will eliminate most noise problems. If you have further problems or questions, please contact Watlow Anafaze.

## General Wiring

---

The following sections explain how to test your installation before you connect power to it and how to connect inputs and outputs to it.

### Power Wiring and Controller Test

When you have installed each component of the controller and the TB-50 (if used), use this checklist to connect them. These instructions are written so that non-electricians can understand them. If you are an experienced electrician, they may seem elementary to you. If so, feel free to skim them.

#### *Connecting Power and TB-50 to CLS*

1. Remove the temporary covers on the CLS housing.
2. The plug-in power supply, included with your controller, has two bare wires. The + side connects to TB2-1, and the - side to TB2-2. As a precaution, you should check the polarity of the wires with a multimeter (color coding of the wires is not always reliable with older power supplies). **Do not turn on the AC power yet.**
3. Connect the ribbon cable to the controller, as shown here. Plug it in so the red stripe is on the left side as you face the back of the controller.

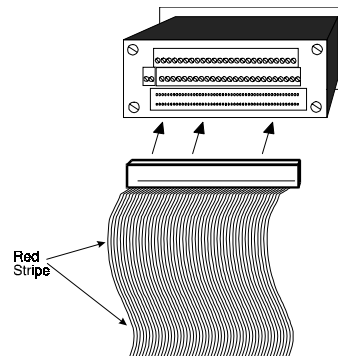

4. Connect the ribbon cable to the TB-50. The cable is keyed, so you cannot insert it backwards.



#### WARNING

**Do not turn on the AC power yet. Test the connections first, as explained in the *Connections Test* section below.**

**Excessive voltage to the CLS will damage it, and you will need to return it to Watlow Anafaze for repair. If you use your own power supply, read the next section completely and follow its instructions before you apply power to the CLS.**

---

### *Connections Test*

Again, follow these instructions if you have purchased your own power supply, or if you are using a Watlow Anafaze power supply, you don't need to perform this test.

1. Unscrew the two screws on the sides of the CLS front panel.
2. Gently slide the electronics assembly out of the case. You have now removed the parts of the CLS which will be damaged by excess voltage, so plug in the transformer power supply and use a voltmeter to check voltages:
3. Touch the meter Common lead to the back Terminal Block 2 (TB2) terminal 2 on the CLS. The voltage on TB2 terminal 1 should then be +12 to 24 Vdc.
4. If the voltages are within the limits described above,
  - a. Turn off power.
  - b. Slide the electronics assembly back into the processor module's casing.
  - c. Reinsert screws into the screw holes on the casing and tighten them.
  - d. Turn the power back on. The CLS display should light up, and after about a second the Bar Graph display should appear.

If you have not connected analog inputs yet, the CLS may display a "T/C Break" alarm message for each channel. This is normal; to clear the alarm messages, press **ALARM ACK** once for each alarm message.

## Outputs

---



---

### NOTE

**Your CLS is shipped with heat outputs enabled and cool outputs disabled. You can disable any PID output and use it for other digital output functions.**

---

All digital outputs and PID outputs are sink outputs referenced to the 5Vdc supply. These outputs are Low (pulled to common) when they are On.

All digital inputs are Transistor-Transistor Logic (TTL) level inputs referenced to control common.

The control outputs are located on the 50 pin header which connects to the TB-18 or TB-50 pin flat ribbon cable. This section explains how to wire and configure them.

### *Wiring Outputs*

The CLS provides dual PID control outputs for each loop. The digital outputs sink current from a load connected to the CLS's internal power supply or from an external power supply referenced to CLS ground.

- If you use an external power supply, do not exceed +12 volts.
- If you tie the external load to ground, or if you cannot connect it as shown below, then use a solid state relay.
- If you connect an external supply to earth or equipment ground, use solid state relays to avoid ground currents. (Ground currents may degrade analog measurements in the CLS).

The outputs conduct current when they are "True". The maximum current sink capability is 20 mA (when all outputs are used). They cannot "source" current to a ground load

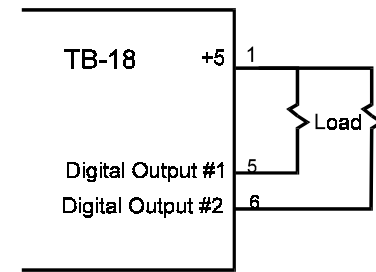

Using internal power supply

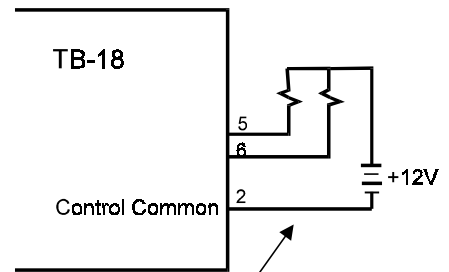

Do not connect to earth or equipment ground

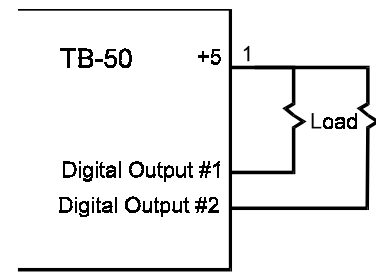

Using internal power supply

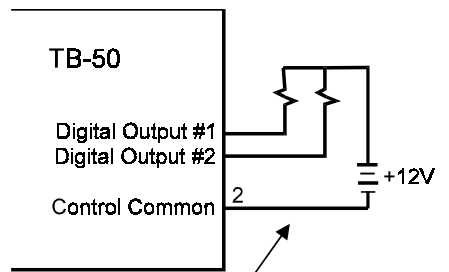

Do not connect to earth or equipment ground

### Using the Cable Tie Wraps

When you have wired outputs to the TB-50, use the cable tie wraps shipped with it. This diagram shows the cable tie wrap holes.

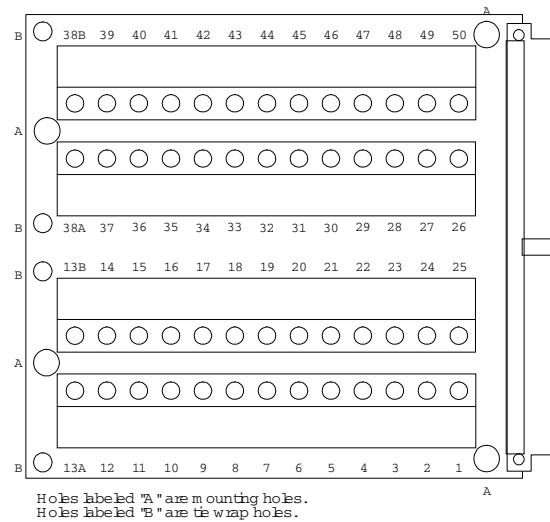

Each row of terminals has a cable tie wrap hole at one end. Thread the cable tie wrap through the cable tie wrap hole. Then wrap the cable tie wrap around the wires attached to that terminal block.

### Configuring Outputs

- You can enable or disable the control outputs. The default setting is heat outputs enabled, cool outputs disabled.
- You can program each control output individually for On/Off, TP, SDAC, or DZC control.
- You can individually program each control output for direct or reverse action.

## PID Control and Alarm Output Connections

Typical digital control outputs use external optically isolated solid-state relays (SSRs). The SSRs use a 3 to 32 Vdc input for control, and you can size them to switch up to 100 amps at 480 Vac. For larger currents, you can use these optically isolated relays to drive contactors. You can also use Silicon Control Rectifiers (SCRs) and an SDAC for phase-angle fired control.



### NOTE

**Control outputs are SINK outputs. They are Low when the output is On. Connect them to the negative side of Solid State Relays.**

The figure below shows sample heat/cool and alarm output connections.

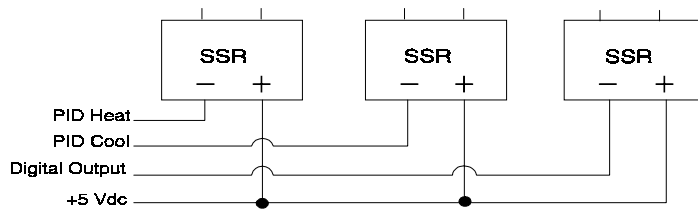

## Watchdog Timer

The CLS watchdog timer constantly monitors the CLS microprocessor. It is a sink output located on TB-18 terminal #3, or on TB-50 terminal #6. (Do not exceed the 10 mAdc rating for the watchdog timer.) Its output is Low (on) when the microprocessor is operating; when it stops operating, the output goes High (off), which de-energizes the SSR.

This figure shows the recommended circuit for the watchdog timer output.

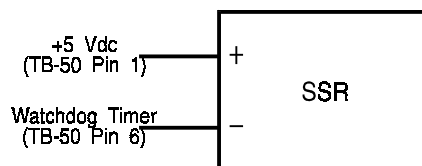
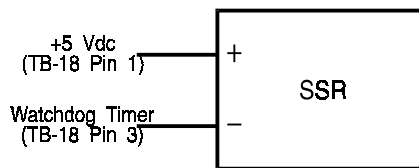

## TB-18 Connections

This table shows TB-18 connections to the 4CLS and the 8CLS.

PIN	Function	PID Output	
		4CLS	8CLS
1	+5 Vdc		
2	Digital ground		
3	Watchdog timer		
4	Global alarm		
5	Digital output 1	Loop 1 heat	Loop 1 heat
6	Digital output 2	Loop 2 heat	Loop 2 heat
7	Digital output 3	Loop 3 heat	Loop 3 heat
8	Digital output 4	Loop 4 heat	Loop 4 heat
9	Digital output 5	Pulse loop heat	Loop 5 heat
10	Digital output 6	Loop 1 cool	Loop 6 heat
11	Digital output 7	Loop 2 cool	Loop 7 heat
12	Digital output 8	Loop 3 cool	Loop 8 heat
13	Digital output 9	Loop 4 cool	Pulse loop heat
14	Digital output 10	Pulse loop cool	Loop 1 cool
15	Digital output 34*	SDAC clock	SDAC clock
16	Digital input 1		
17	Digital input 2		
18	Digital input 3 /Pulse input		

\*If you install a Watlow Anafaze Serial DAC (SDAC), the CLS uses digital output #34 for a clock line. You cannot use output #34 for anything else when you have an SDAC installed.

TB-50 Connections

4 and 8 CLS TB-50 Connections.

Pin	Function	PID Output*		Pin	Function	PID Output*	
		8CLS	4CLS			8CLS	4CLS
1	+5 Vdc			2	+5 Vdc		
3	CTRL COM			4	CTRL COM		
5	Not Used			6	Watchdog Timer		
7	Pulse Input			8	Global Alarm		
9	DIG output 1	Loop 1 heat	Loop 1 heat	10	DIG output 34*		
11	DIG output 2	Loop 2 heat	Loop 2 heat	12	DIG output 33		
13	DIG output 3	Loop 3 heat	Loop 3 heat	14	DIG output 32		
15	DIG output 4	Loop 4 heat	Loop 4 heat	16	DIG output 31		
17	DIG output 5	Loop 5 heat	Pulse loop heat	18	DIG output 30		
19	DIG output 6	Loop 6 heat	Loop 1 cool	20	DIG output 29		
21	DIG output 7	Loop 7 heat	Loop 2 cool	22	DIG output 28		
23	DIG output 8	Loop 8 heat	Loop 3 cool	24	DIG output 27		
25	DIG output 9	Pulse loop heat	Loop 4 cool	26	DIG output 26		
27	DIG output 10	Loop 1 cool	Pulse loop cool	28	DIG output 25		
29	DIG output 11	Loop 2 cool		30	DIG output 24		
31	DIG output 12	Loop 3 cool		32	DIG output 23		
33	DIG output 13	Loop 4 cool		34	DIG output 22		
35	DIG output 14	Loop 5 cool		36	DIG output 21		
37	DIG output 15	Loop 6 cool		38	DIG output 20		
39	DIG output 16	Loop 7 cool		40	DIG output 19		
41	DIG output 17	Loop 8 cool		42	DIG output 18	Pulse loop cool	
43	DIG input 1			44	DIG input 2		
45	DIG input 3			46	DIG input 4		
47	DIG input 5			48	DIG input 6		
49	DIG input 7			50	DIG input 8		

If you install a Watlow Anafaze Serial Digital to Analog Converter (SDAC), the CLS uses digital output #34 for a clock line. You cannot use output #34 for anything else when you have an SDAC installed.

\* The indicated outputs are dedicated to PID (or control) when enabled in the loop setup. If one or both of a loop's outputs are disabled, the corresponding digital outputs become available for alarms or ramp/soak events.

## 16 CLS TB-50 Connections.

Pin	Function	PID Output*	Pin	Function	PID Output*
1	+5 Vdc		2	+5 Vdc	
3	Digital Ground		4	Digital Ground	
5	Not Used		6	Watchdog Timer	
7	Pulse Input		8	Global Alarm	
9	DIG output 1	Loop 1 heat	10	DIG output 34*	Pulse loop cool
11	DIG output 2	Loop 2 heat	12	DIG output 33	Loop 16 cool
13	DIG output 3	Loop 3 heat	14	DIG output 32	Loop 15 cool
15	DIG output 4	Loop 4 heat	16	DIG output 31	Loop 14 cool
17	DIG output 5	Loop 5 heat	18	DIG output 30	Loop 13 cool
19	DIG output 6	Loop 6 heat	20	DIG output 29	Loop 12 cool
21	DIG output 7	Loop 7 heat	22	DIG output 28	Loop 11 cool
23	DIG output 8	Loop 8 heat	24	DIG output 27	Loop 10 cool
25	DIG output 9	Loop 9 heat	26	DIG output 26	Loop 9 cool
27	DIG output 10	Loop 10 heat	28	DIG output 25	Loop 8 cool
29	DIG output 11	Loop 11 heat	30	DIG output 24	Loop 7 cool
31	DIG output 12	Loop 12 heat	32	DIG output 23	Loop 6 cool
33	DIG output 13	Loop 13 heat	34	DIG output 22	Loop 5 cool
35	DIG output 14	Loop 14 heat	36	DIG output 21	Loop 4 cool
37	DIG output 15	Loop 15 heat	38	DIG output 20	Loop 3 cool
39	DIG output 16	Loop 16 heat	40	DIG output 19	Loop 2 cool
41	DIG output 17	Pulse loop heat	42	DIG output 18	Loop 1 cool
43	DIG input 1		44	DIG input 2	
45	DIG input 3		46	DIG input 4	
47	DIG input 5		48	DIG input 6	
49	DIG input 7		50	DIG input 8	

If you install a Watlow Anafaze Serial digital to Analog Converter (SDAC), the CLS uses digital output #34 for a clock line. You cannot use output #34 for anything else when you have an SDAC installed.

\* The indicated outputs are dedicated to PID (or control) when enabled in the loop setup. If one or both of a loop's outputs are disabled, the corresponding digital outputs become available for alarms or ramp/soak events.

---

## Inputs

This section covers input scaling and input installation for all input types, including thermocouples, RTDs, current inputs, and voltage inputs.

### Input Scaling

The CLS analog input circuitry accepts any mix of thermocouples, 2 or 3 wire RTD inputs, current inputs, and voltage inputs. You can directly connect the following inputs:

- J, K, T, S, R, B, and E thermocouples.
- Linear inputs with ranges between -10 and 60 mV.

Other inputs require custom scaling resistors. If you didn't order your unit with the appropriate resistors, you have the following options:

- Watlow Anafaze can install scaling resistors on your unit for a nominal fee.
- Watlow Anafaze can supply a scaling resistor kit that a qualified technician can use to install scaling resistors.



#### WARNING

**A qualified technician can install scaling resistors in the CLS. However, damage to the CLS due to improper resistor installation is not covered under warranty, and repairs can be expensive. If you have any doubts about your ability to install scaling resistors, send your CLS to Watlow Anafaze for resistor installation.**

---

## 4 and 8 CLS Scaling Values

- For RTD1 inputs, RA and RB are a matched pair (RP). Their matching tolerance is 0.02% (2 ppm/°C) and their absolute tolerance is 0.1% (10 ppm/°C). RC has 0.05% tolerance.
- For RTD2 inputs, use 0.05% tolerance resistors.
- For linear mVdc, Vdc, and mAdc ranges, use 0.1% tolerance resistors. Higher tolerances may cause significant errors. Correct any errors due to resistor tolerance with the CLS's built-in linear scaling. You can also install other components (like capacitors) for signal conditioning; please consult Watlow Anafaze for more information.

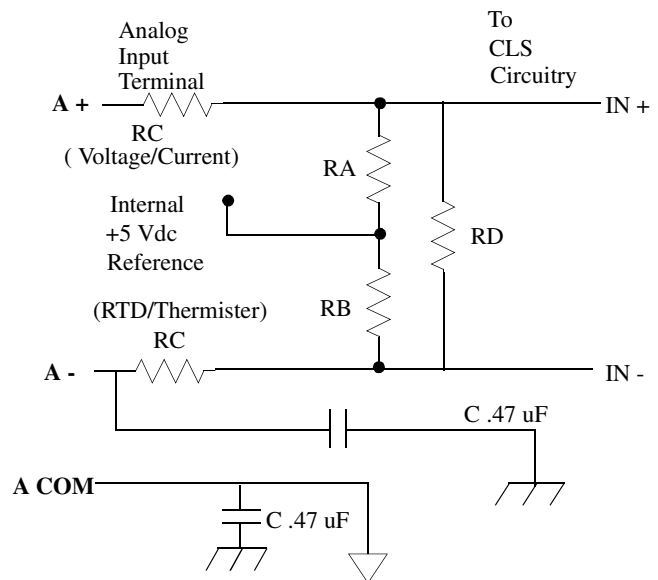

### NOTE

**When adding your own scaling resistors to the 4 and 8 CLS, the shorting pads of the RC must be cut before installing to the bottom of the PC board.**

The next table shows scaling resistor values.

Input Range	RA	RB	RC	RD
All T/C, 0-60 mV DC			Jumper	
RTD 1: -100.0 to 275.0°C RTD 2: -120 to 840°C	10.0 Kohms 25.0 Kohms	10.0 Kohms 25.0 Kohms	80 ohms 100 ohms	
0-10 mA DC 0-20 mA DC			Jumper Jumper	6.0 ohms 3.0 ohms
0-100 mV 0-500 mV			499 ohms 5.49 Kohms	750 ohms 750 ohms
0-1 VDC 0-5 VDC 0-10 VDC 0-12 VDC			6.91 Kohms 39.2 Kohms 49.9 Kohms 84.5 Kohms	422.0 ohms 475.0 ohms 301.0 ohms 422.0 ohms

The following tables show the location of RA, RB, RC and RD on the analog input boards of the 4CLS and the 8CLS. (The analog input board is the upper board of the two-board set.)

*4CLS: Voltage/Current Inputs*

Loop #	RC	RD
1	58	RP1
2	56	RP2
3	54	RP3
4	52	RP4

*8CLS: Voltage/Current Inputs*

Loop	RC	RD
1	58	RP1
2	56	RP2
3	54	RP3
4	52	RP4
5	50	RP5
6	48	RP6
7	46	RP7
8	44	RP8

*4CLS: RTD/Thermister Inputs*

Loop #	RA/RB	RC
1	RP1	57
2	RP2	55
3	RP3	53
4	RP4	51

*8CLS: RTD/Thermister Inputs*

Loop	RA/RB	RC
1	RP1	57
2	RP2	55
3	RP3	53
4	RP4	51
5	RP5	49
6	RP6	47
7	RP7	45
8	RP8	43

Place resistors RA, RB and RD in the resistor pair locations this way:

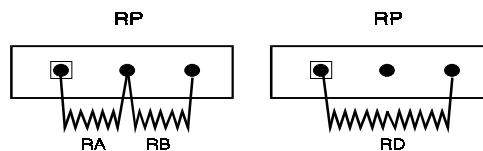

A wire trace on the printed circuit board jumpers the RC position. When you place a resistor in the RC position, cut the wire trace that connects the two resistor terminals.

## 16 CLS Scaling Values

For linear mVdc, Vdc, and mA dc ranges, use 0.1% tolerance resistors. Higher tolerances may cause significant errors. Correct any errors due to resistor tolerance with the CLS' built-in linear scaling. You can also install other components (like capacitors) for signal conditioning; please consult Watlow Anafaze for more information.

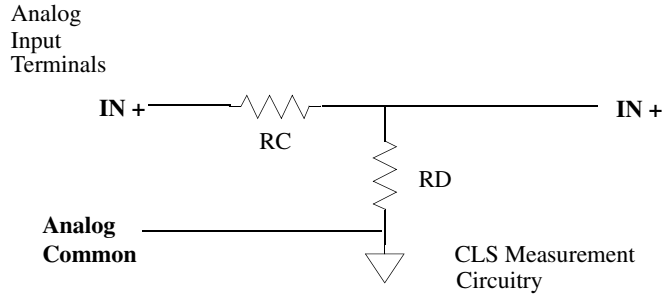

The next table shows scaling resistor values.

Input Range	RC	RD
All T/C, 0-60 mV DC	Jumper	
0-10 mA DC	Jumper	6.0 ohms
0-20 mA DC	Jumper	3.0 ohms
0-100 mV	499 ohms	750 ohms
0-500 mV	5.49 Kohms	750 ohms
0-1 VDC	6.91 Kohms	422.0 ohms
0-5 VDC	39.2 Kohms	475.0 ohms
0-10 VDC	49.9 Kohms	301.0 ohms
0-12 VDC	84.5 Kohms	422.0 ohms

The next table shows the location of RC and RD on the analog input board. (The analog input board is the upper board of the two-board set.)

Loop #	RC	RD	Loop #	RC	RD
1	R58	R42	9	R57	R41
2	R56	R40	10	R55	R39
3	R54	R38	11	R53	R37
4	R52	R36	12	R51	R35
5	R50	R34	13	R49	R33
6	R48	R32	14	R47	R31
7	R46	R30	15	R45	R29
8	R44	R28	16	R43	R27

A wire trace on the printed circuit board jumpers the RC position. When you place a resistor in the RC position, cut the wire trace that connects the two resistor terminals.

## Scaling and Calibration

The CLS provides offset calibration for thermocouple, RTD, and other fixed ranges, and offset and span (gain) calibration for linear and pulse inputs. (Offset and span calibration convert linear analog inputs into engineering units using the  $Mx+B$  function.)

In order to scale linear input signals, you must:

1. Install appropriate scaling resistors. (Contact Watlow Anafaze's Customer Service Department for more information about installing scaling resistors.)
2. Select the display format. The smallest possible range is  $-9999$  to  $+3.0000$ ; the largest possible range is  $-9999$  to  $30000$ .
3. Enter the appropriate scaling values for your process.

For more information about input scaling and input offset, see **Setup Loop Inputs** in **Chapter 4: Setup**.

## T/C Inputs



---

### WARNING

**The CLS uses a floating ground system. Therefore:**

**Isolate input devices or host computers connected through communications cables (like RS-232) from earth ground.**

**Use ungrounded thermocouples with the thermocouple sheath electrically connected to earth ground.**

**Use optically isolated RS-232 devices to isolate earth grounded host computers from the CLS.**

**When you use grounded T/Cs, tie the thermocouple shields to a common earth ground in one place. Otherwise any common mode voltages that exceed 5 volts may cause incorrect readings or damage to the controller.**

---



---

### WARNING

**The 16CLS has single ended inputs, offering little protection from common mode voltage sources. Therefore Watlow Anafaze highly recommend that you use ungrounded thermocouples with the external thermocouple sheath electrically connected to earth ground.**

---

You can connect J, K, T, S, R, B, and E thermocouples directly to the CLS. Watlow Anafaze provides standard linearization and cold junction compensation for these thermocouple types. (Other thermocouple types require custom linearization; please contact Watlow Anafaze for more information about them.)

### Connecting Thermocouples

Connect the positive T/C lead to the IN+ terminal. Connect the negative T/C lead to the TB1 In- (4 or 8CLS) or analog common 16CLS)( terminal. A typical thermocouple connection is shown in the figure below.

- Use 20 gauge thermocouple extension wire for all thermocouple inputs.
- If you use shielded wire, tie it to panel ground or to ground at the measurement end.

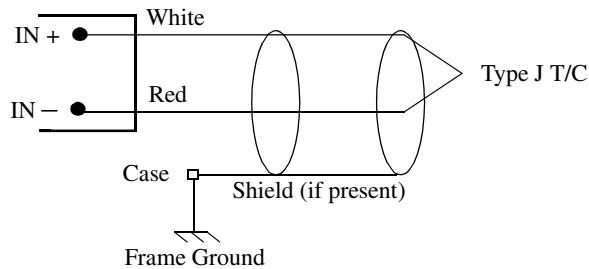

### RTD Inputs (4 and 8 CLS only)

The standard industrial RTD is an 100-ohm, 3-wire platinum assembly as shown in the figure below. Watlow Anafaze highly recommends that you use the 3-wire RTD to prevent reading errors due to cable resistance.

- If you order an RTD1 or RTD2 configuration, Watlow Anafaze will configure your CLS for the standard 3-wire RTD.
- If you must use a 4-wire RTD, leave the fourth wire unconnected.

Watlow Anafaze offers 2 standard DIN 385 curve RTD input ranges, as shown here:

RTD Ranges in Degrees						
Name	Temp. Range in °F	Temp. Range in °C	Resolution	Measurement Temperature	Error @ 25 °C Ambient	Error @ 0-50 °C Ambient
RTD1	-148.0 to 527.0 °F	-100.0 to 275.0 °C	0.023 °C	25 °C	±0.35 °C	±0.5 °C
				275 °C	±1 °C	±1.5 °C
RTD2	-184 to 1544 °F	-120 to 840 °C	0.062 °C	25 °C	±0.9 °C	±2.8 °C
				840 °C	±1.1 °C	±4.3 °C

Below is a typical RTD.

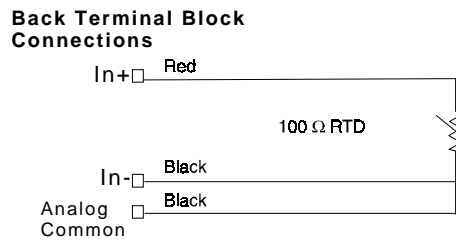

## Current Inputs

To connect current (milliamp) inputs, install resistors that convert the milliamp input to a voltage. Watlow Anafaze offers resistors for 0-20 mA and 0-10 mA current inputs.

## Voltage Inputs

- Connect the + side of the voltage input to the In+ terminal.
- Connect the - side of the input to the In- terminal for the 4 and 8CLS, or analog common for the 16CLS. The 0voltage input range is -10 to 60 mV.
- Scale signals larger than 60 mV with scaling resistors that make full scale input 60 mV. (For more information, see the Input Scaling section.)

The figures below show typical voltage input.

16CLS

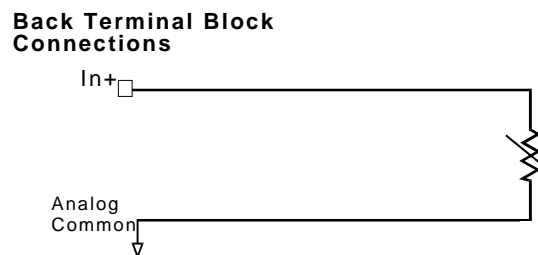

4 and 8 CLS

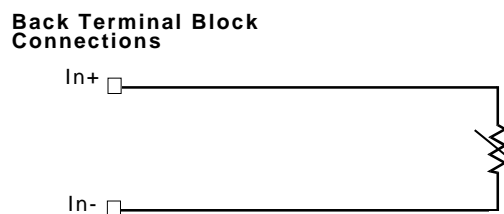

## Unused Inputs

Set the input type for unused inputs to “SKIP” to avoid the default T/C break alarms. (See Input Type in Chapter 4: Setup for information on setting the input type.)

## Back Terminal Block Connections

Wire inputs to the back terminal block as shown below.

### 4CLS

<b>TB1</b>		<b>1</b>	<b>3</b>	<b>5</b>	<b>7</b>	<b>9</b>	<b>11</b>	<b>13</b>	<b>15</b>	<b>17</b>	<b>19</b>	<b>21</b>	<b>23</b>	<b>25</b>		
		CH 1 IN+	CH 2 IN+	Ana- log Com	CH 3 IN+	CH 4 IN+	Ana- log Com	Re- ser- ved	Re- ser- ved	Ref. Com	Re- ser- ved	Re- ser- ved	GND / RXB	RX / RXA		
<b>TB2</b>		<b>1</b>	<b>2</b>													
		+V pwr	Pwr Com	<b>2</b>	<b>4</b>	<b>6</b>	<b>8</b>	<b>10</b>	<b>12</b>	<b>14</b>	<b>16</b>	<b>18</b>	<b>20</b>	<b>22</b>	<b>24</b>	<b>26</b>
		CH 1 IN-	CH 2 IN-	Ana- log Com	CH 3 IN-	CH 4 IN-	Ana- log Com	Re- ser- ved	Re- ser- ved	+5V Ref.	Re- ser- ved	Re- ser- ved	GND / TXB	TX / TXA		

### 8CLS

<b>TB1</b>		<b>1</b>	<b>3</b>	<b>5</b>	<b>7</b>	<b>9</b>	<b>11</b>	<b>13</b>	<b>15</b>	<b>17</b>	<b>19</b>	<b>21</b>	<b>23</b>	<b>25</b>		
		CH 1 IN+	CH 2 IN+	Ana- log Com	CH 3 IN+	CH 4 IN+	Ana- log Com	CH 5 IN+	CH 6 IN+	Ref. Com	CH 7 IN+	CH 8 IN+	GND / RXB	RX / RXA		
<b>TB2</b>		<b>1</b>	<b>2</b>													
		+V pwr	Pwr Com	<b>2</b>	<b>4</b>	<b>6</b>	<b>8</b>	<b>10</b>	<b>12</b>	<b>14</b>	<b>16</b>	<b>18</b>	<b>20</b>	<b>22</b>	<b>24</b>	<b>26</b>
		CH 1 IN-	CH 2 IN-	Ana- log Com	CH 3 IN-	CH 4 IN-	Ana- log Com	CH 5 IN-	CH 6 IN-	+5V Ref.	CH 7 IN-	CH 8 IN-	GND / TXB	TX / TXA		

### 16 CLS

<b>TB1</b>		<b>1</b>	<b>3</b>	<b>5</b>	<b>7</b>	<b>9</b>	<b>11</b>	<b>13</b>	<b>15</b>	<b>17</b>	<b>19</b>	<b>21</b>	<b>23</b>	<b>25</b>		
		CH 1 IN+	CH 2 IN+	Ana- log Com	CH 3 IN+	CH 4 IN+	Ana- log Com	CH 5 IN+	CH 6 IN+	Ref. Com	CH 7 IN+	CH 8 IN+	GND / RXB	RX / RXA		
<b>TB2</b>		<b>1</b>	<b>2</b>													
		+V pwr	Pwr Com	<b>2</b>	<b>4</b>	<b>6</b>	<b>8</b>	<b>10</b>	<b>12</b>	<b>14</b>	<b>16</b>	<b>18</b>	<b>20</b>	<b>22</b>	<b>24</b>	<b>26</b>
		CH 9 IN+	CH 10 IN+	Ana- log Com	CH 11 IN+	CH 12 IN+	Ana- log Com	CH 13 IN+	CH 14 IN+	+5V Ref.	CH 15 IN+	CH 16 IN+	GND / TXB	TX / TXA		

---

## Serial Communications

The CLS is factory-configured for RS-232 communications. However, the communications are jumper-selectable, so you can switch between RS-232 and RS-485. (See *Configuring Communications* below.) You can also order a communications cable from Watlow Anafaze or make your own cable.

### RS-232 Interface

With RS-232 communications, you can connect the CLS directly to the serial communications connector on an IBM-PC or compatible computer. (PC-compatible computers typically use RS-232 communications.) The RS-232 interface is a standard three-wire interface. See the table below for connection information. (Some computers reverse transmit (TX) and receive (RX), so check your computer manual to verify your connections.)

You can use either RS-232 or RS-485 communications in these situations:

- When you are using local communications (up to 50 feet).
- When you are using a single CLS.

If you are using RS-232 communications with grounded thermocouples, use an optical isolator between the controller and the computer.

This table shows RS-232 connections for 25-pin and 9-pin connectors.

DB 25 Connector	DB 9 Connector	CLS Back TB	Watlow Anafaze Cable
RX Pin 3	RX Pin 2	TX Pin 26	White
TX Pin 2	TX Pin 3	RX Pin 25	Red
GND Pin 7	GND Pin 5	GND Pin 23	Black

### RS-485 Interface

- If you use more than one CLS, you must use RS-485 communications.
- If you have connected the CLS to a computer more than 50 feet away, Watlow Anafaze recommends that you use RS-485 communications.

If you use RS-485 communications, attach an optically isolated RS-232 to RS-485 converter to the computer. You can use an internal converter card or an external plug-in converter.

The diagram on the next page shows the recommended system hookup. To avoid ground loops, it uses an optically isolated RS-232 to RS-485 converter at the host computer. The system is powered from the CLS's power source or from a secure, isolated supply.

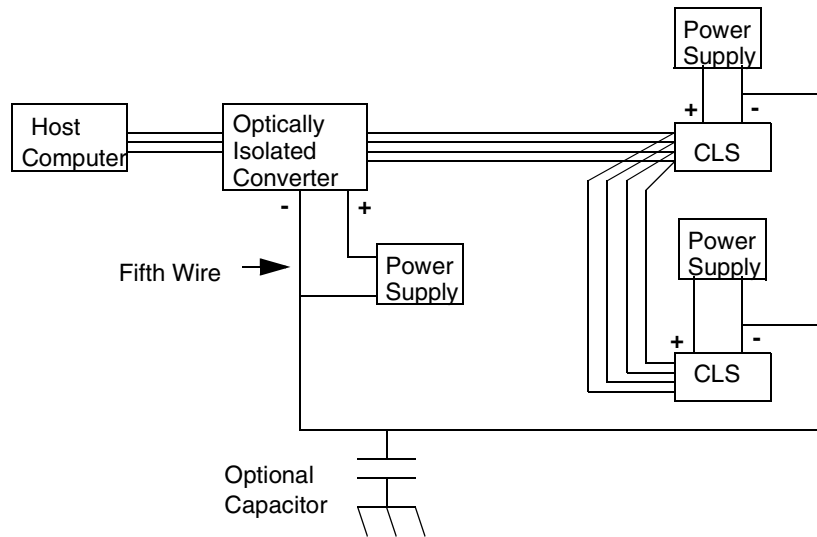

Wire equipment in a single "daisy chain" using twisted shielded pairs for the RS-485 cables. Don't use "octopus connections" or "spurs".

Use a 200 ohm terminating resistor on the RX line of the last controller in the system. (If you have only one controller, it is the last controller in the system.) Use jumper JU1 to select the terminating resistor; place it in B position for termination and A position for non-termination.

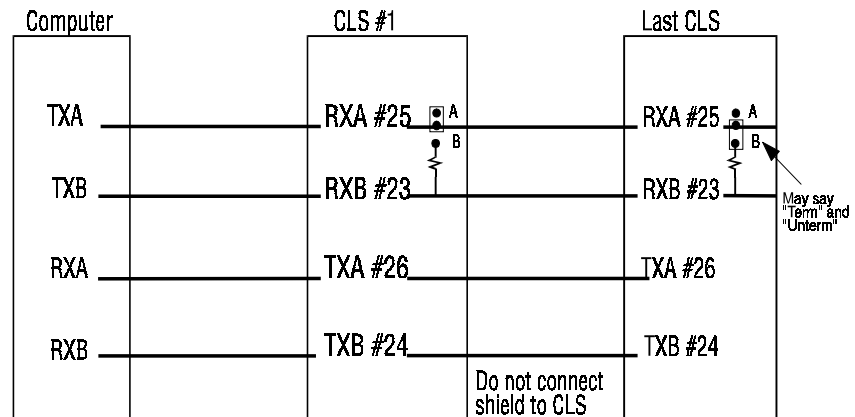

**NOTE**

**Connect the shields to earth ground only at the computer or other 485 interface. Do not connect the shield to the controller.**

**If you connect RS-485 communications and they do not function properly, or if you have measurement problems when communications lines are connected, request additional technical information from the Watlow Anafaze Customer Service Department.**

## Configuring Communications

Your controller is shipped configured for RS-232. To switch between RS-232 and RS-485, change the jumpers as shown here.

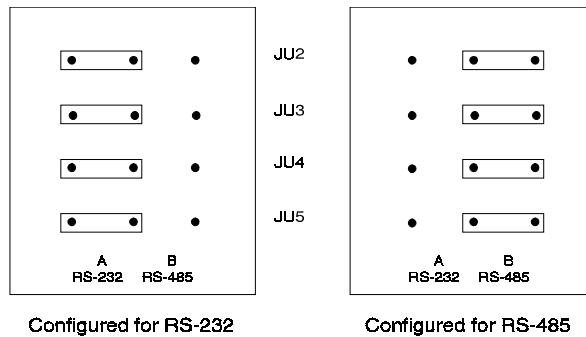

You'll need tweezers and a Phillips head screwdriver to switch between RS-232 and RS-485. Follow these steps:

1. Power down the unit.
2. Remove the controller's metal casing. If you haven't removed the casing before, please don't try to figure it out yourself; see Changing the PROM in the *Troubleshooting* section for step-by-step instructions.
3. Find jumpers JU2, JU3, JU4, and JU5 (above).
4. (This part of the explanation assumes that you're changing the communications from RS-232 to RS-485. If you're not, follow the next two steps but move the jumpers from the B position to the A position.) Use tweezers to carefully grasp the jumpers and gently slide them off the pins.
5. Use tweezers to gently slide the jumpers onto the B pins. Move jumpers JU2, JU3, JU4, and JU5 to the B position, as shown above.
6. If you have changed the controller to 485 communications, put the 200 ohm terminating resistor on the RX line of the last controller in the system. (If you're only using one controller, it's the last controller in the system.) Place jumper JU1 in the B position. All other controllers in the system should have JU1 in the A position.
7. Put the casing back on. If you haven't removed or reinstalled the CLS's casing before, see **Chapter 7: Troubleshooting** for instructions.

*Recommended Wire Gauges*

Watlow Anafaze recommends the following maximum distances and wire gauges:

Distance	Wire Gauge	Recommended Cable
4000 ft.	24 AWG	Belden #9729 Belden #9842
6000 ft.	22 AWG	Belden #9184

You may wish to use a shield, depending on your noise environment and grounding problems. The above cables are shielded.

**NOTE**

**These recommendations are conservative, to ensure that your controller will operate reliably. Expect satisfactory performance even if you must deviate slightly from a design specification.**



# Using the CLS

## Introduction

This chapter will show you how to use the CLS from the front panel. (If you are using ANASOFT or AnaWin, please see the related User's Guide.) The next diagram shows how to reach the operator menus from Single Loop display. (To change global parameters, loop inputs, control parameters, outputs, and alarms from the setup menu, you must enter a special sequence of keys. To learn how, see the next chapter: *setup*.)

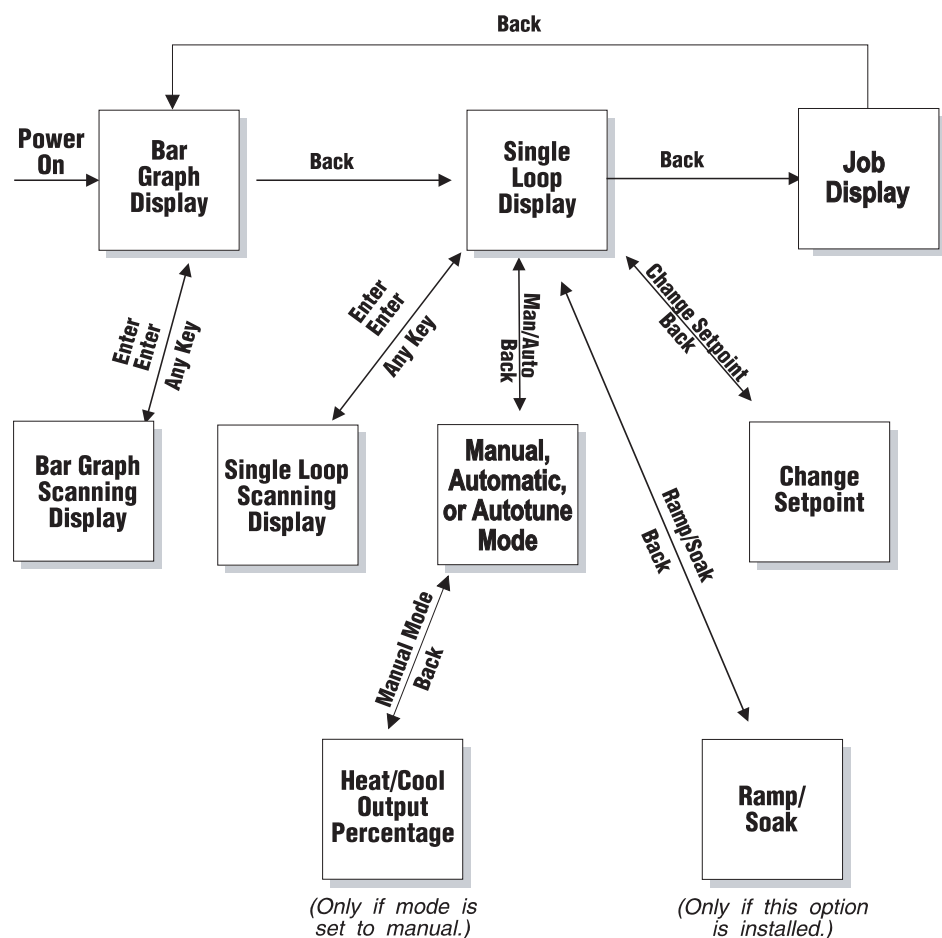

## Front Panel

The front panel provides a convenient interface with the controller. You can program and operate the CLS with the front panel keys shown below, or you can use ANASOFT, a program designed specifically for Watlow Anafaze controllers.

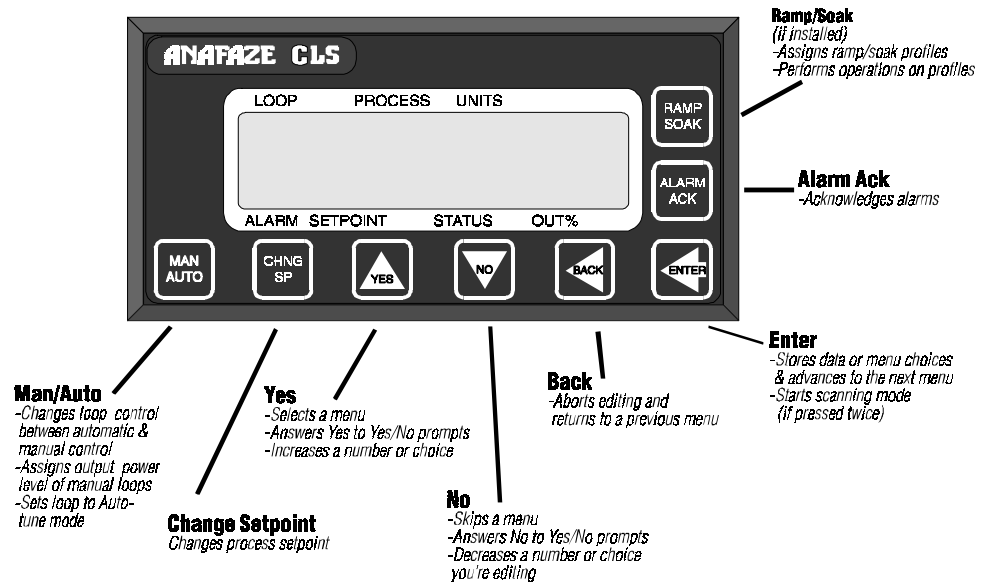

## Front Panel Keys



### Yes/Up

Press **Yes** to

- Select a menu.
- Answer **Yes** to **Yes/No** questions.
- Increase a number or choice you're editing.



### No/Down

Press **No** to

- Skip a menu you don't want to edit, when the prompt is blinking.
- Answer **No** to **Yes/No** prompts.
- Decrease a number or choice when editing.
- Perform a **No** Key Reset.



---

**WARNING**

**Pressing the No key on power up will clear the RAM memory and reinitialize the CLS' factory default values.**

---

To do a No Key Reset, power down the controller, press and hold the No key, and power up the controller while holding the No key. A No Key Reset is appropriate:

- After you change the EPROM. (See Chapter 6: Troubleshooting.)
- In some cases when troubleshooting (see Chapter 6: Troubleshooting).
- When you install the controller.

### *Back*



The **Back** key works like an “escape key”. Press it to:

- Abort editing.
- Return to a previous menu.
- Switch between Bar Graph, Single Loop, and Job Control displays.

### *Enter*



Press **Enter** to:

- Store data or menu choices after editing and go on to the next menu.
- Start scanning mode (if pressed twice).

### *Change SP*

- Press this key to change the loop setpoint.



### *Man/Auto*

Press the **Man/Auto** key to:



- Toggle a loop between manual and automatic control.
- Adjust the output power level of loops in Manual control.
- Automatically tune a loop.



## *Ramp/Soak*

If Ramp/Soak is installed on your controller, press the **Ramp/Soak** key to:

- Assign a ramp/soak profile to the current loop.
- Perform operations on an assigned profile.
- See the status of a running profile.



---

### NOTE

Your CLS may not have the Ramp/Soak feature. If it does not, then the Ramp/Soak key will not operate. If you press the Ramp/Soak key, you'll see the following message:



## *Alarm Ack*

Press **Alarm Ack** to acknowledge an alarm condition and reset the global alarm digital output.



## Displays

The next section discusses the CLS' main displays--Bar Graph, Single Loop, and Job displays.

### Bar Graph Display

On power up, the CLS displays general symbolic information for all four primary loops. This display is called Bar Graph mode. The diagram below shows the symbols used in Bar Graph mode.

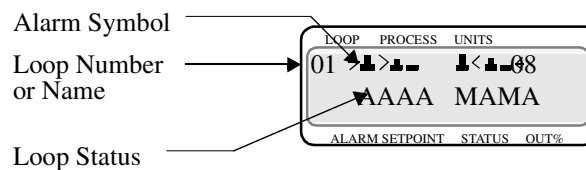

The next table explains the symbols you see on the top line of the Bar Graph display. These symbols appear when the controller is in dual output mode (heat and cool outputs enabled) and single output mode (heat or cool outputs enabled, but not both).

Symbol	Symbol's Meaning
<	Loop is in low process or low deviation alarm.
>	Loop is in high process or high deviation alarm.
	Loop is above setpoint. If you enable the high or low deviation alarm, this symbol is scaled to it. If you don't enable these alarms, these symbols are scaled to the setpoint $\pm 5\%$ of the sensor's range.
	Loop is at setpoint. If you enable the high or low deviation alarm, this symbol is scaled to it. If you don't enable these alarms, these symbols are scaled to the setpoint $\pm 5\%$ of the sensor's range.
	Loop is below setpoint. If you enable the high or low deviation alarm, this symbol is scaled to it. If you don't enable these alarms, these symbols are scaled to the setpoint $\pm 5\%$ of the sensor's range.
(Blank)	Loop is set to SKIP.
F	Sensor has failed.

The next table explains the symbols you see on the bottom line of Bar Graph display. These symbols appear when the controller is in both dual output mode and single output mode. If an alarm occurs, the controller automatically switches to Single Loop display and shows an alarm code.

Symbol	Symbol's Meaning
M	One or both outputs enabled. Loop is in manual control.
A	Only one output (heat or cool, but not both) is enabled. Loop is in automatic control.
T	Loop is in Autotune mode.
H T	Both heat and cool outputs are enabled. Loop is in Automatic control and heating.
C L	Both heat and cool outputs are enabled. Loop is in Automatic control and cooling.

### Navigating in Bar Graph Display

- Press **Yes** (up) or **No** (down) to see Bar Graph Display for the Pulse Input loop.
- Press **Enter** twice to start Bar Graph scanning mode. In scanning mode, the controller alternately displays the first four loops and then the pulse input loop for three seconds each.
- Press **any key** to stop scanning mode.
- From Bar Graph Display, press **Back** once to go to Single Loop display.

### Single Loop Display

Single Loop display (below) shows detailed information for only one loop. If the heat and cool outputs are enabled, Single Loop display looks like this:

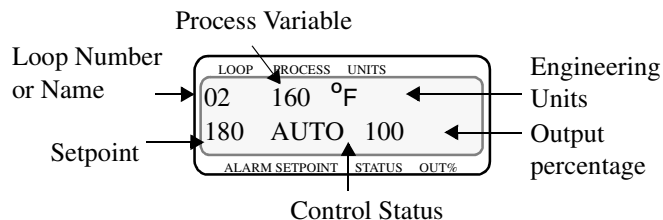

The control status indicator shows HEAT or COOL if the loop is in automatic control, and MAN or TUNE if the loop is in manual control.

If only one output is enabled (heat or cool, but not both), Single Loop display looks like this:

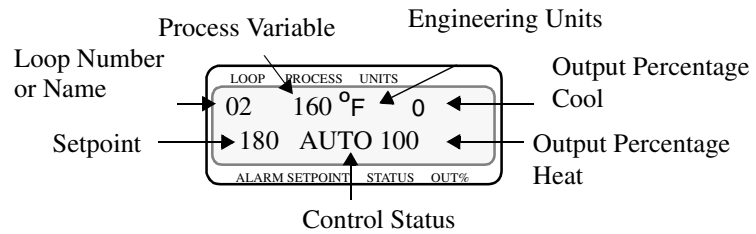

From Single Loop Display,

- Press **Yes** to go to the next loop.
- Press **No** to go to the previous loop.
- Press the **Back** key once to go to Job display (if enabled) or Bar Graph display.
- Press **Enter** twice to start Single Loop Scanning display. (The Single Loop Scanning Display shows information for each loop in sequence. Data for each loop displays for one second.)
- Press any key to stop scanning mode.

## Alarms

If an alarm occurs, a two-character alarm code appears in the lower left corner of the display (below). If a Failed Sensor alarm occurs, the controller also displays a short alarm message.

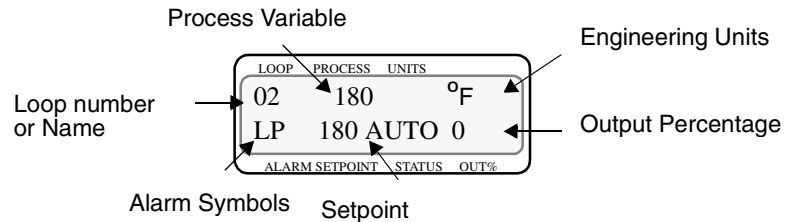

These alarm codes and messages are shown in the table below.

Symbol	Alarm Message	Alarm Type
FS	TC Break	Thermocouple break
FS (RO)	RTD Open	RTD break
FS (RS)	RTD Short	RTD Short
HP	No message	High process alarm
HD	No message	High deviation alarm
LD	No message	Low deviation alarm
LP	No message	Low process alarm

### *Acknowledging an Alarm*

Press Alarm Ack to acknowledge the alarm. If there are other loops with alarm conditions, the Alarm display switches to the next loop in alarm. Acknowledge all alarms to clear the global alarm digital output. (You must acknowledge each alarm before displays and keyboard operation will resume.)



#### NOTE

In the 4 and 8 CLS, the controller cannot detect all RTD open and RTD short failures. Detection of open or shorted RTDs depends on which wires are open or shorted.

## Job Display

---

Job display appears only if:

- You have turned on the Remote Job Select function. (This function is explained in *Setup*.)
- You have selected a job from the job load menu.

When you load a job, Job display shows you the following screen:

LOOP	PROCESS	UNITS
JOB	3	RUNNING
ALARM SETPOINT	STATUS	OUT%

If you remotely loaded the job, Job display looks like this:

LOOP	PROCESS	UNITS
JOB	3	RUNNING
REMOTELY LOADED		
ALARM SETPOINT	STATUS	OUT%

If you modify a job's parameters while the job is running, you'll see this job message:

LOOP	PROCESS	UNITS
JOB	3	RUNNING
DATA MODIFIED		
ALARM SETPOINT	STATUS	OUT%

If an alarm occurs, the controller switches to Single Loop Display.

## Operator Menus

---

You can reach the following Operator Menus from Single Loop Display. (If your CLS is already installed, try each procedure as you read about it.)

### Change Setpoint

To change the setpoint, go to Single Loop display of the loop you wish to change, and then press the Change Setpoint key. (The setpoint is the desired temperature, pH, et cetera, for the process.) You should see a display like this:

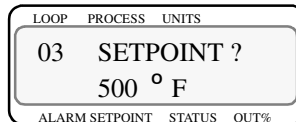

- Press **Yes** to change the setpoint.
- Then press **Yes** or **No** to change the setpoint value.
- When you are satisfied with the setpoint value you have chosen, press **Enter** to save your changes and return to Single Loop Display; or
- To return to Single Loop display without saving your changes, press **No** or **Back**.

### Manual/Automatic Control

Press the **Man/Auto** key to set a loop's control mode, set manual output levels, or automatically tune a loop. The control mode determines whether the CLS automatically controls the process according to the configuration information you give it (Automatic control), or you set the output to a constant level (Manual control).

If both outputs are disabled when you press the Man/Auto key, you'll see a display like this one:



Press any key to exit this display. If at least one control output (heat or cool) is enabled, you'll see this display:

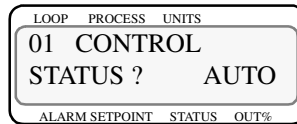

- Press **Yes** to change the mode.
- Press **Yes** or **No** to switch between Manual, Automatic, and Tune.
- To exit this menu and return to the Single Loop Display without saving your changes, press **Back**.
- Press **Enter** to save your changes. If you have set the mode to Manual, you can now set the manual heat and cool output levels.

### *Manual Output Levels*

The Manual Output Levels menu will only appear if you have set the current loop to Manual control. This menu lets you set the manual output levels for the enabled outputs. The cool output menu is just like the heat output menu, except that the word COOL replaces the word HEAT in the display. You should see a display like the one below:



- Press **Yes** to change the output power.
- Then press **Yes** or **No** to select a new output power level.
- When you are satisfied with the power level you have chosen, press **Enter** to store your changes.
- To discard your changes and return to Single Loop display, press **Back**.

### *Autotune*

If you set the current loop's control status to TUNE and press Enter, the controller automatically sets the loop to Manual control, 100% output. (If you selected a continuous output limit, the controller sets the loop to the output limit.) The autotune function then calculates the appropriate PID constants for the loop and puts the loop in automatic control with the calculated PID values.

The Autotune function will abort if:

- Process variable goes over 75% of the setpoint. Remember, the controller is at 100% output or at the output limit you set.
- It has not calculated PID constants after 10 minutes (due to heater failure, sensor failure, et cetera.)

If the autotune function aborts, it puts the loop into its previous control state (Automatic control or Manual control at the previous output percentages.)

To automatically tune a loop, follow these steps:

1. Make sure the process is cold (or stable and well below setpoint).
2. Initiate Autotune:
  - a. Use the front panel keypad to go to Single Loop Display
  - b. Press the Man/Auto key
  - c. Choose Tune
  - d. Press Enter.

The Tune indicator will begin flashing and the controller will go back to Single Loop Display. The Tune indicator will keep flashing as long as the loop is tuning.

### Ramp/Soak

If you have a CLS without the Ramp/Soak option, pressing the Ramp/Soak key has no effect. If you have a CLS with Ramp/Soak installed, please refer to the ***Ramp/Soak Appendix*** at the end of this manual.

# Setup

The Setup menus let you change the CLS detailed configuration information.

If you have not set up a CLS before, or if you don't know what values to enter, please read first the *Tuning and Control* section, which contains PID tuning constants and useful starting values.

## How to Enter the Setup Menus?

1. In Single Loop Display, select the loop you wish to edit.
2. While still in Single Loop Display, enter the pass sequence below:  
Press **Enter**, **Alarm Ack**, **Change Setpoint**.



3. The first setup menu appears.



---

### NOTE

**For your protection, CLS reverts to Single Loop Display If you don't make any changes for three minutes.**

---

## How to edit a menu?

- Press **Yes** to select this menu or **No** to advance to the next menu.
- press **Yes** or **No** to toggle between the options in your menu.
- Press **Enter** to store the value you have selected.
- If you decide not to edit the menu, press **Back** to stop editing and return to the main menu.

Each display contains the default value for that specific menu, and below each display you will see the range of choices for that menu.

The following sections tell more about the submenus for each of the six main menus. If you have a CLS with the Ramp/Soak option, there will also be a Ramp/Soak menu. (Please refer to the Ramp/Soak documentation included with your CLS for use instructions.)

The next page shows the setup menus accessible from Single Loop Display.

Setup Global Parameters?	Setup Loop Inputs?	Setup Loop Control Params?	Setup Loop Outputs?	Setup Loop Alarms?	Manual I/O Test?
Load setup from job?	Input type?	Heat control PB?	Heat control output?	Hi proc alarm setpt?	Digital inputs
Save setup to job?	Pulse sample time?	Heat control TI?	Heat output type?	Hi proc alarm type?	Test digital output?
Job select dig inputs?	Loop name?	Heat control TD?	Heat output cycle time? (TP)	Hi proc alarm output?	Keypad test
Job sel dig ins active?	Input units?	Heat control filter?	SDAC menus (SDAC only)	Dev alarm value?	
Output override dig input?	Input reading offset ? (T/C)	Cool control PB?	Heat output action?	Hi dev alarm type?	
Override dig in active?	Disp format? (Linear)	Cool control TI?	Heat output limit?	Hi dev alarm output?	
Startup alarm delay?	Input scaling Hi PV? (Linear & Pulse)	Cool control TD?	Heat output limit time?	Lo dev alarm type?	
* Ramp/Soak time base? (only if R/S installed)	Input scaling Hi RDG? (Linear & Pulse)	Cool control filter?	Heat override output?	Lo dev alarm output?	
Keyboard lock status?	Input scaling Lo PV? (Linear & Pulse)	Heat/Cool spread?	Heat output?	Lo dev alarm output?	
Power up output status?	Input scaling Lo RDG? (Linear & Pulse)		Cool control output?	Lo proc alarm setpt?	
Controller address?	Input Filter?		Cool output type?	Lo proc alarm type?	
Communications baud rate?			Cool output cycle time? (TP)	Lo proc alarm output?	
Communication protocol?			SDAC menus (SDAC only)	Alarm dead-band?	
Communications ERR check?			Cool output action?	Alarm delay?	
AC line freq?			Cool output limit?		
Dig out polarity on alarm?			Cool output limit time?		
EPROM information			Cool override output?		
			Cool output?		

**\* If Ramp/Soak is installed in your controller, see *Ramp/Soak Appendix* at the end of this Guide.**

## Set up Global Parameters Menu

The Set up Global Parameters menu looks like this:

LOOP	PROCESS	UNITS
<b>SETUP GLOBAL PARAMETERS ?</b>		
ALARM SETPOINT	STATUS	OUT%

Below is the setup global parameters menu tree. Notice the default values inside the boxes.:

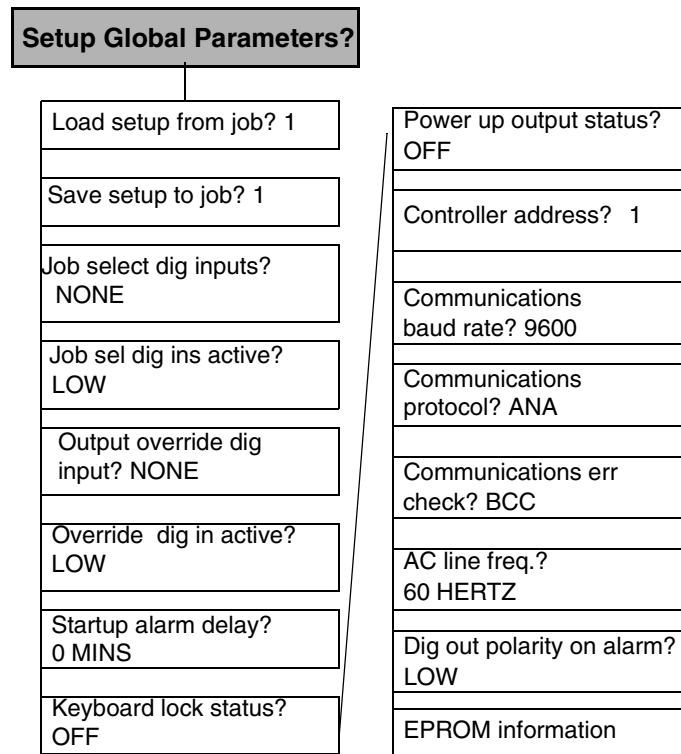

## Load a Job

Use this menu to load any one of 8 saved jobs from the controller's front panel.



The following parameters are loaded as part of a job:

- PID constants, filter settings, setpoints and spread values
- Loop control status (Automatic or Manual) and output values (if the loop is in Manual control).
- Alarm functions (Off, Alarm, Control), setpoints, high\low process setpoints, high\low deviation setpoints and deadband settings, and loop alarm delay.



---

### WARNING

**All current job settings will be overwritten if you select a job from memory. Save your current programming to a job number if you want to keep it.**

---

If you have enabled the remote job control function, this menu will be disabled; you will not be able to load a job from the front panel. If you try it, you'll see the message below.



## Save Setup to Job

Use this menu to save the job information for every loop to one of 8 jobs in the CLS' battery-backed RAM.



If you have enabled the remote job control function, you will not be able to save a job. If you try it, you'll see this message:



## Job Select Inputs

Use this menu to set the number of job select inputs. The controller uses these inputs as a binary code that specifies the job number to run. The number of inputs you choose in this menu controls the number of jobs you can select remotely.

LOOP	PROCESS	UNITS
JOB SELECT		
DIG INPUTS ? NONE		
ALARM SETPOINT	STATUS	OUT%

Below is the truth table that tells you which input states select which jobs.

Digital Input 3	Digital Input 2	Digital Input 1	Job #
F	F	F	1
F	F	T	2
F	T	F	3
F	T	T	4
T	F	F	5
T	F	T	6
T	T	F	7
T	T	T	8

**Selectable values:** 1, 2, or 3 inputs, or None. These choices have the following effect:

Setting	Enables
1 input	Jobs 1-2
2 inputs	Jobs 1-4
3 inputs	Jobs 1-8
None (no inputs)	Remote Select disabled

## Job Select Input Polarity

Use this menu to set the polarity of the digital outputs used for job selection.

LOOP	PROCESS	UNITS
JOB SEL DIG INS		
ACTIVE ? LOW		
ALARM SETPOINT	STATUS	OUT%

**Selectable values:** High or Low.

When nothing is connected, the inputs are all False and Job 1 is selected (as shown in the truth table above).

## Output Override Digital Input

Use this menu to set a digital input that sets all loops in manual output at output levels you select in the **Outputs** menu. This menu, and the next one, let you configure a “panic button” or “kill switch” that sets all outputs to the output override percentage you set in the **Set up Loop Outputs** main menu.

LOOP	PROCESS	UNITS
OUTPUT OVERRIDE		
DIG INPUT ? NONE		
ALARM SETPOINT	STATUS	OUT%

**Selectable values:** NONE or input number 1-8.



---

### WARNING

**Watlow Anafaze recommends that you install additional external safety devices or over-temperature devices for emergency shutdowns. Do not rely solely on the output override feature to shut down your process.**

---

## Output Override Input Polarity

Use this menu to toggle the polarity of the Output Override digital input. You can set the input to be active when Low or active when High.

LOOP	PROCESS	UNITS
OVERRIDE DIG IN		
ACTIVE ? LOW		
ALARM SETPOINT	STATUS	OUT%

**Selectable values:** High or Low.

## Start-up Alarm Delay

Use this menu to set a start-up delay for process and deviation alarms for all loops. The controller does not report these alarm conditions for the specified number of minutes after the controller powers up. (The controller will always report failed sensor alarms, no matter what start-up delay you set.)

LOOP	PROCESS	UNITS
STARTUP ALARM		
DELAY ? 0 mins		
ALARM SETPOINT	STATUS	OUT%

**Selectable values:** 0-60 minutes.

## Keyboard Lock Status

Use this menu to lock the front panel operator function keys **Change SP**, **Man/Auto**, and **Ramp/Soak** so that pressing these keys has no effect. If you want to use these functions, turn off the Keyboard Lock.



**Selectable values:** On or Off.

## Power-Up Output Status

Use this menu to set the initial power-up state of the control outputs to Off or Memory. If you choose Off, all control outputs are initially set to Manual mode at 0% output level. If you choose Memory, the outputs are restored to the last output state stored in memory.



### WARNING

---

**Do not set the CLS to start from memory if a memory-based restart is unsafe for your process.**

---

**Selectable values:** Off or Memory.

## Controller Address

Use this menu to set the CLS address. The controller address is used for multiple controller communications on a single 485 cable, so each CLS must have a different address. Begin with address 1 for the first controller and assign each subsequent controller the next higher address.



**Selectable values:** 1-32.

## Communications Baud Rate

Use this menu to set the Communications Baud Rate.

LOOP	PROCESS	UNITS
COMMUNICATIONS BAUD RATE ? 9600		
ALARM SETPOINT	STATUS	OUT%

**Selectable values:** 2400 or 9600.

## Communications Protocol

Use this menu to set the communications protocol type.

LOOP	PROCESS	UNITS
COMMUNICATIONS PROTOCOL ? ANA		
ALARM SETPOINT	STATUS	OUT%

**Selectable values:** ANA (Watlow Anafaze's protocol), AB (Allen Bradley's), MOD (Modbus).

## Communications Error Checking

This menu appears only when you choose ANA or AB as your communications protocol. Use it to set the data check algorithm used in the CLS communications protocol to Block Check Character (BCC) or to Cyclic Redundancy Check (CRC).

LOOP	PROCESS	UNITS
COMMUNICATIONS ERR CHECK ? BCC		
ALARM SETPOINT	STATUS	OUT%

**Selectable values:** BCC or CRC.

CRC is a more secure error checking algorithm than BCC, but it requires more calculation time and slows the CLS communications. BCC ensures a high degree of communications integrity, so Watlow Anafaze recommends that you use BCC unless your application specifically requires CRC



---

### NOTE

**If you are using ANASOFT, be sure to configure ANAIN-STL for the same Error Checking method and the same Baud Rate that you set in this menu and in the next one.**

---

## AC Line Frequency

Use this menu to configure the controller to match an AC line frequency of 50 or 60 Hz. (This function is provided for international users who require 50 Hz lines.) Since the controller reduces the effect of power line noise on the analog measurement by integrating the signal over the period of the AC line frequency, the controller's noise rejection will suffer if the line frequency is not set correctly.

LOOP	PROCESS	UNITS
AC LINE FREQ ?		
60 HERTZ		
ALARM SETPOINT	STATUS	OUT%

**Selectable values:** 50 Hz or 60 Hz.



---

### NOTE

**You must switch power to the CLS on and off for a change in AC line frequency to take effect.**

---

## Digital Output Polarity

Use this menu to set the polarity of the digital outputs used for alarms.

LOOP	PROCESS	UNITS
DIG OUT POLARITY		
ON ALARM ? LOW		
ALARM SETPOINT	STATUS	OUT%

**Selectable values:** High or Low.

## EPROM Information

This is a view-only display. It shows the controller's EPROM version and checksum.

LOOP	PROCESS	UNITS
CLS164		
V03.02 CS=2233		
ALARM SETPOINT	STATUS	OUT%

Press any key to return to the Set up Global Parameters menu.

## Set up Loop Input

The Set up Loop Input main menu lets you access menus which change parameters related to the loop input:

- Input type
- Input units
- Input scaling and calibration
- Input filtering

The next section explains how to use the Input menus to configure your controller.

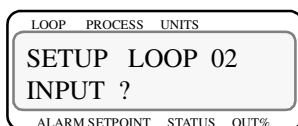

Below is the setup inputs menu tree. Notice the default values inside the boxes.

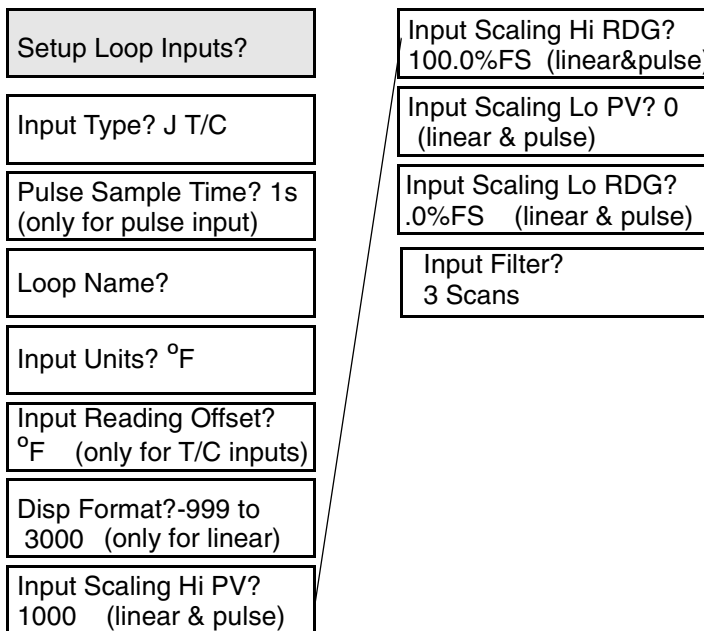

## Input Type

Use this menu to configure the input sensor for each loop as one of these input types:

- Thermocouple types (J, K, T, S, R, B and E).
- RTD (4 and 8CLS). Two ranges: RTD1 (Platinum Class A) and RTD2 (Platinum Class B).
- Linear inputs.
- Skip (an input type available for unused channels.) The scanning display doesn't show loops you've set to Skip.

LOOP	PROCESS	UNITS
01 INPUT		
TYPE ? J T/C		
ALARM SETPOINT	STATUS	OUT%

The following tables show the input types and ranges.

Input Type	Range in °F	Range in °C	* Accuracy: 25°C Ambient		* Accuracy: 0-50°C Full Temp. Range	
			°C	°F	°C	°F
J T/C	-350 to 1400	-212 to 760	±0.5	±0.9	±1.1	±2.0
K T/C	-450 to 2500	-268 to 1371	±0.6	±1.2	±1.35	±2.7
T T/C	-450 to 750	-268 to 399	±1.3	±2.4	±2.9	±5.4
S T/C	0 to 3200	-18 to 1760	±2.5	±4.5	±5.6	±10.1
R T/C	0 to 3210	-18 to 1766	±2.5	±4.5	±5.6	±10.1
B T/C	150 to 3200	66 to 1760	±6.6	±12.0	±14.9	±27.0
E T/C	-328 to 1448	-200 to 787				
Pulse	0-2 KHz					
Skip	Loop is not scanned or displayed					
Linear	See the Linear Scaling section					
* True for 10% to 100% of span.						

## RTD Ranges (4 and 8CLS)

Name	Range in °F	Range in °C	Resolution	Probe Temp. In °C	Accuracy: 25°C Ambient		Accuracy: 0-50°C Ambient	
					°C	°F	°C	°F
RTD1	-148.0 to 527.0	-100.0 to 275.0	0.023 °C	25	±0.35	±0.63	±0.5	±0.9
				275	±1	±1.8	±1.5	±2.7
RTD2	-184 to 1544	-120 to 840	0.062 °C	25	±0.9	±1.62	±2.8	±5.04
				840	±1.1	±1.98	±4.3	±7.74

## Pulse Sample Time

You can connect a digital pulse signal of up to 2 KHz to the controller's pulse input. In this menu, you specify the pulse sample period. (This is the second menu of the Set up Loop Inputs menu for the pulse input loop only.) Every sample period, the number of pulses the controller receives is divided by the sample time. The controller scales this number and uses it as the pulse loop's process variable.

LOOP	PROCESS	UNITS
05	INPUT PULSE	
	SAMPLE TIME ?	1s
	ALARM SETPOINT	STATUS OUT%

**Selectable Range:** 1-20 seconds.

## Loop Name

Use this menu to name your loop using two-characters. After specifying a new name, it is placed on the single loop display instead of the loop's number.

LOOP	PROCESS	UNITS
A5	LOOP	
	NAME ?	A5
	ALARM SETPOINT	STATUS OUT%

## Input Units

Use this menu to choose a three-character description of the loop's engineering units

LOOP	PROCESS	UNITS
02	INPUT	
	UNITS ?	°F
	ALARM SETPOINT	STATUS OUT%

**Selectable values:** The table below shows the character set for input units.

Input	Character Sets for Units
Thermocouple, and RTD	°F or °C
Linear & Pulse	0 to 9, A to Z, %, /, degrees, space

## Input Reading Offset

**This menu does not appear if the input type is linear, pulse, or skip.** Use it to make up for the input signal's inaccuracy at any given point. For example, at temperatures below 400 °F, a type J thermocouple may be inaccurate (“offset”) by several degrees F. Use an independent thermocouple or your own calibration equipment to find the offset for your equipment. To correct for offset errors, change the factory default setting to a positive or negative value for the loop you are editing. (A positive value increases the reading and a negative value decreases it.)

LOOP	PROCESS	UNITS
02 INPUT READING		
OFFSET ?		0 °F
ALARM SETPOINT	STATUS	OUT%

**Selectable range:** For thermocouples, infrared inputs and RTD2s, the offset correction ranges from -300 to +300.

For RTD1s and IR inputs set to Average mode, the offset range is 300.0 to +300.0.

## Linear Scaling Menus

The linear scaling menus appear under the Set up Loop Inputs main menu. Linear scaling is available for linear and pulse inputs only. It lets you scale the “raw” input readings (readings in millivolts or Hertz) to the engineering units of the process variable.



### NOTE

**Linear scaling menus appear only if the loop's input type is set to Linear (or, for some menus, to Pulse).**

For linear inputs, the input reading is in percent (0 to 100%) representing the 0-60 mV input range of the CLS. For pulse inputs, the input reading is in Hertz (cycles per second.)

The scaling function is defined by two points on a conversion line. It relates the high PV to the high reading and the low PV to the low reading to define the line. The engineering units of the process variable can be any arbitrary units. The graph below shows PSI as an example.

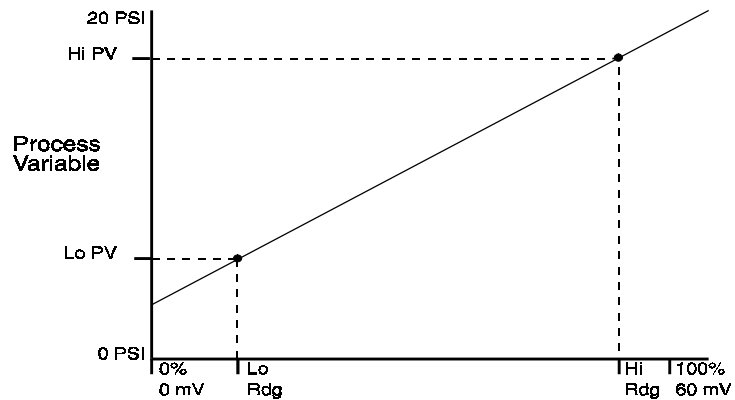

Before you enter the values that determine the two points for the conversion line, you must choose an appropriate display format. The CLS has six characters available for process variable display; select the setting with the desired number of decimal places before and after the decimal point. Use a display format that matches the range and resolution of the process variable. The display format you choose is used for the setpoint, alarms, deadband, spread, and proportional band.

The PV (Process Variable) range for the scaled input is between the PV values that correspond to the 0% and 100% input readings. For the pulse input, it is between the 0 Hz and 2000 Hz readings. This PV range defines the limits for the setpoint and alarms, as shown here.

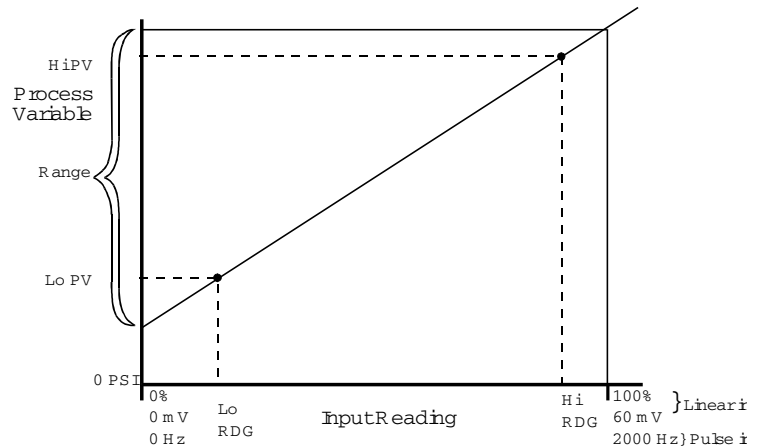

**NOTE**

**For example linear scaling calculations, see *Linear Scaling* section.**

## Display Format

This menu appears under the Set up Loop Inputs main menu. It lets you select a display format for a linear input. Choose a format appropriate for your input range and accuracy. (You will only see the Display Format menu if you are editing a linear input.)

LOOP	PROCESS	UNITS
04 DISP FORMAT ?		
-999 to 3000		
ALARM SETPOINT	STATUS	OUT%

**Selectable values:** The CLS has several available display formats, as shown below. This table also shows the high and low PV values.

Display Format	Default High PV	Default Low PV
-9999 to +30000	10000	0
-999 to +3000	1000	0
-999.9 to +3000.0	1000.0	.0
-99.99 to +300.00	100.00	.00
-9.999 to +30.000	10.000	.000
-.9999 to +3.0000	1.0000	.0000

## High Process Value

This menu appears under the Set up Loop Inputs main menu. Use it to enter a high process value. The high process value and the high reading value together define one of the points on the linear scaling function's conversion line.

LOOP	PROCESS	UNITS
01 INPUT SCALING		
HI PV ? 1000 °F		
ALARM SETPOINT	STATUS	OUT%

**Selectable values:** See table on the previous page.

## High Reading

Use this menu to enter the input level that corresponds to the high process value you entered in the previous menu. For linear inputs, the high reading is a percentage of the full scale input range. For pulse inputs, the high reading is expressed in Hz.

The 100% full scale input value is 60 mV for the linear input type.

LOOP	PROCESS	UNITS
04 INPUT SCALING		
HI RDG ? 100.0%FS		
ALARM SETPOINT	STATUS	OUT%

**Selectable range:** Any value between -99.9 and 999.9. However, you cannot set the high reading to a value less than or equal to the low reading.

## Low Process Value

Use this menu to set a low process value for input scaling purposes. The low process value and the low reading value together define one of the points on the linear scaling function's conversion line.

LOOP	PROCESS	UNITS
01 INPUT SCALING		
LO PV ? 0 °F		
ALARM SETPOINT	STATUS	OUT%

**Selectable values:** See table under *Display Format*.

## Low Reading

Use this menu to enter the input level that corresponds to the low process value you selected in the previous menu. For linear inputs, the low reading is a percentage of the full scale input range; for pulse inputs, the low reading is expressed in Hz.

LOOP	PROCESS	UNITS
01 INPUT SCALING		
LO RDG ? 0.0%FS		
ALARM SETPOINT	STATUS	OUT%

The full scale input value for the linear input type is 60 mV. For pulse inputs, it is 2000 Hz.

**Selectable range:** 99.9-999.9. You cannot set the low reading to a value greater than or equal to the high reading.

## Input Filter

The CLS has two different types of input filter:

- A noise rejection filter that rejects high frequency input signal noise. This filter keeps a “trend log” of input readings. If a reading is outside the filter's “acceptance band”, and later readings are within the acceptance band, the CLS ignores the anomalous reading. (The acceptance band for thermocouples is 5 degrees above and 5 degrees below the input reading. For linear inputs, it's 0.5% above and 0.5% below the input reading.) If later readings are also outside the acceptance band, the CLS accepts the anomalous reading and calculates a new acceptance band. (You cannot adjust this input filter.)
- A standard resistor-capacitor (RC) filter that lets you dampen the input response if inputs change unrealistically or change faster than the system can respond. If the input filter is enabled, the process variable responds to a step change by going to 2/3 of the actual value within the number of scans you set.

If all input loops are enabled (none of them are set to SKIP) the CLS scans each input loop 6 times per second. The input filter applies to all input types except those set to SKIP.

LOOP	PROCESS	UNITS
01	INPUT FILTER ?	
	3 SCANS	
ALARM SETPOINT	STATUS	OUT%

**Selectable range:** 0-255 scans. 0 disables the filter.

---

## Set up Loop Control Parameters

Use these menus to change control parameters for heat and cool outputs of the selected loop, including:

- Proportional Band (PB or Gain), Integral (TI or Reset), and Derivative (TD or Rate) settings.
- Output Filter.
- Spread between heat and cool outputs.

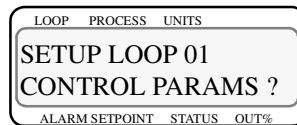

Below is the setup control parameters menu tree.





---

### NOTE

**Both heat and cool outputs have the same menus, so only one of each menu is shown here. The controller will show both heat and cool menus even if the heat or cool output is disabled. (See Set up Loop Outputs for help enabling or disabling the heat or cool output.)**

**Refer to *Tuning and Control* for help in selecting control parameter values.**

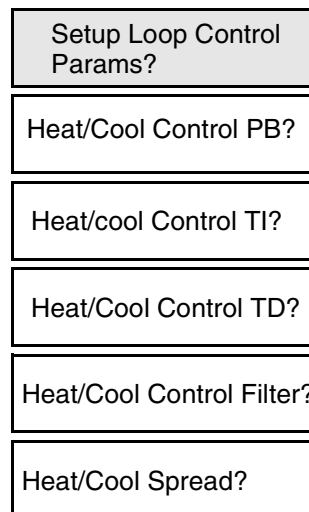
---



## Heat or Cool Control PB

This menu allows you to set the Proportional Band (also known as Gain).

LOOP	PROCESS	UNITS
02	HEAT CONTROL	
	PB?	50 °F
ALARM SETPOINT	STATUS	OUT%



### NOTE

The CLS internally represents the proportional band (PB) as a gain value. When you edit the PB, you'll see the values change in predefined steps--small steps for narrow PB values and large steps for wide PB values.

The controller calculates the default PB for each input type according to the following equation:

$$\text{Default PB} = \frac{(\text{High Range} - \text{Low Range})}{\text{Gain}}$$

## Heat or Cool Control TI

This menu lets you set the Integral term, or Reset.

LOOP	PROCESS	UNITS
02	HEAT CONTROL	
	TI ?	180 Sec/R
ALARM SETPOINT	STATUS	OUT%

**Selectable range:** 0 (off) - 6000 seconds.

## Heat or Cool Control TD

This menu lets you set the derivative constant.

LOOP	PROCESS	UNITS
03	HEAT CONTROL	
	TD ?	0 sec
ALARM SETPOINT	STATUS	OUT%

**Selectable range:** 0-255 seconds.

## Heat or Cool Output Filter

Use this menu to dampen the heat or cool output's response. The output responds to a step change by going to approximately 2/3 of its final value within the number of scans you set here.

LOOP	PROCESS	UNITS
04	HEAT CONTROL	
FILTER ?	2	SCANS
ALARM SETPOINT	STATUS	OUT%

**Selectable range:** 0-255. Setting the output filter to 0 turns it off.

## Heat and Cool Spread

Use this menu to set the spread between the heat and cool output and the spread of the On/Off control action.

LOOP	PROCESS	UNITS
01	SPREAD ?	
5	°F	
ALARM SETPOINT	STATUS	OUT%

**Selectable ranges:** 0 - 255, 25.5, 2.55, .255 or .0255, depending on the way you set up the Input menus.

## Set up Loop Outputs

Press **Yes** at this prompt to access menus to change loop output parameters for the current loop, including:

- Enable or disable outputs
- Output type
- Cycle time (for TP outputs)
- SDAC parameters (for SDAC outputs)
- Control action
- Output level limit and limit time
- Output override
- Nonlinear output curve

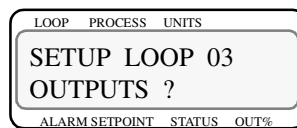

Below is the setup outputs menu tree. Both heat and cool outputs have the same menus, so only one of each menu is shown here.

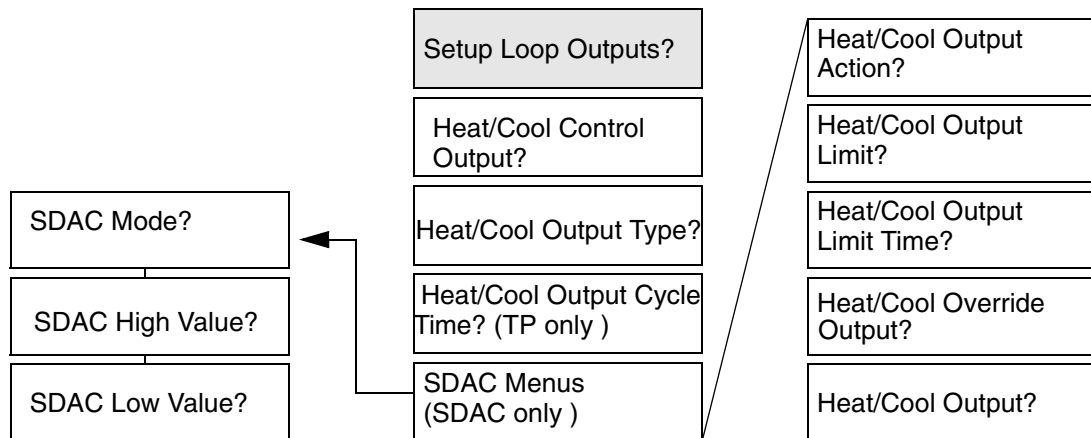

## Enable/Disable Heat or Cool Outputs

From this menu you can enable or disable the heat or cool output for the current loop. If you want the loop to have PID control, you must enable one output. You can also disable a heat or cool control output and use the output pin for something else, like an alarm.



**Selectable values:** Enabled or Disabled.

## Heat or Cool Output Type

This menu lets you set the output type.

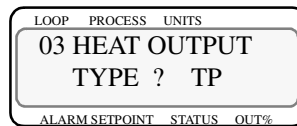

This table shows the available output types.

Display Code	Output Type	Definition
TP	Time proportioning	Percent output converted to a percent duty cycle over the programmed cycle time.
DZC	Distributed Zero Crossing	Output on/off state calculated for every AC line cycle.
SDAC	Serial DAC	Output type for optional Serial Digital to Analog Converter.
ON/OFF	On / Off	Output either full ON or full OFF.

For an expanded description of these output types, see *Tuning and Control*.

## Heat or Cool Cycle Time

From this menu you can set the Cycle Time for Time Proportioning outputs.

LOOP	PROCESS	UNITS
02	HEAT OUTPUT	
CYCLE TIME ? 10 s		
ALARM SETPOINT	STATUS	OUT%



---

### NOTE

**The Cycle Time menu will only be present if the output type for the current loop is Time Proportioning.**

---

**Selectable range:** 1-255 seconds.

---

## SDAC Menus

If you attach the optional SDAC to an output, you must configure that output for the SDAC using the following series of menus. The CLS will also assign digital output #34 as a clock line for the SDAC. You won't be able to assign another function to output #34 while any loop's output is set to SDAC.

### SDAC Mode

From this menu you can toggle the SDAC between current and voltage output. The SDAC menus only appear if the output type for the loop is set to SDAC.

LOOP	PROCESS	UNITS
01	SDAC MODE ?	
VOLTAGE		
ALARM SETPOINT	STATUS	OUT%

**Selectable values:** Current or voltage.

## SDAC High Value

Use this menu to set a high value for the SDAC output. Set the high and low value to match the range of the output device. For instance, if the output device has a 4-20 mA range, set the SDAC high value to 20.00 mA and the SDAC low value to 4.00 mA. The controller converts 0% output to a 4.00 mA signal and 100% output to a 20.00 mA signal.

LOOP	PROCESS	UNITS
03	SDAC HI VALUE	
?	10.00	VDC
ALARM SETPOINT	STATUS	OUT%

**Selectable values:** If the output is set to Voltage, the default high value is 10.00 volts. If the output is set to Current, the default high value is 20.00 mA. You cannot set the high value to be less than or equal to the low value.

## SDAC Low Value

Use this menu to set a low value for the SDAC output. Set the high and low value to match the range of the output device. For instance, if the output device has a 0.00-10.00 V range, set the SDAC high value to 10.00 V and the SDAC low value to 0.00 V. The controller converts 0% output to a 0.00 V signal and 100% output to a 10.00 V signal.

LOOP	PROCESS	UNITS
04	SDAC LO VALUE	
?	0.00	VDC
ALARM SETPOINT	STATUS	OUT%

**Selectable values:** If the output is set to Voltage, the default low value is 0.00 volts. If the output is set to Current, the default low value is 4.00 mA. You cannot set the low value to be greater than or equal to the high value.

## Heat or Cool Output Action

Use this menu to select the control action for the current output. Normally, heat outputs are set to reverse action and cool outputs are set to direct action.

LOOP	PROCESS	UNITS
01	HEAT OUTPUT	
	ACTION ? REVERSE	
ALARM SETPOINT	STATUS	OUT%

**Selectable values:** Reverse or direct. For heat outputs, set to reverse; for cool outputs, set to direct.

## Heat or Cool Output Limit

Use this menu to limit the maximum PID control output for a loop's heat and cool outputs. This limit may be continuous, or it may be in effect for a specified number of seconds (see Output Limit Time below). If you choose a timed limit, the output limit restarts when the controller powers up and when the output goes from Manual to Automatic control (via the front panel, when the controller changes jobs, or from ANASOFT). The output limit only affects loops under automatic control. It does not affect loops under manual control.

LOOP	PROCESS	UNITS
01	HEAT OUTPUT	
	LIMIT ?	100%
ALARM SETPOINT	STATUS	OUT%

**Selectable range:** 0-100%.

## Heat or Cool Output Limit Time

Use this menu to set a time limit for the output limit.

LOOP	PROCESS	UNITS
03	HEAT OUTPUT	
	LIMIT TIME ?	CONT
ALARM SETPOINT	STATUS	OUT%

**Selectable values:** 1-999 seconds (1 second to over 16 minutes), or to CONT (continuous).

## Heat or Cool Output Override

Use this menu to set an output override percentage. (You can configure a digital input for the output override in the **Set up Global Parameters** main menu.) If the current loop is in Automatic mode and a sensor failure occurs, the loop switches to the output override percentage. If you change the polarity of the override output to the active state--for instance, by flipping a "kill switch" you have set up--every loop switches to the output override percentage you set here.

LOOP	PROCESS	UNITS
03	HEAT OVERRIDE	
	OUTPUT ?	0%
ALARM SETPOINT	STATUS	OUT%

**Selectable range:** 0-100%.

## Heat or Cool Nonlinear Output Curve

Use this menu to select one of two nonlinear output curves for nonlinear processes.

LOOP	PROCESS	UNITS
03	HEAT OUTPUT ?	
LINEAR		
ALARM SETPOINT	STATUS	OUT%

**Selectable values:** Curve 1, Curve 2, or Linear.

These curves are shown in the figure below.

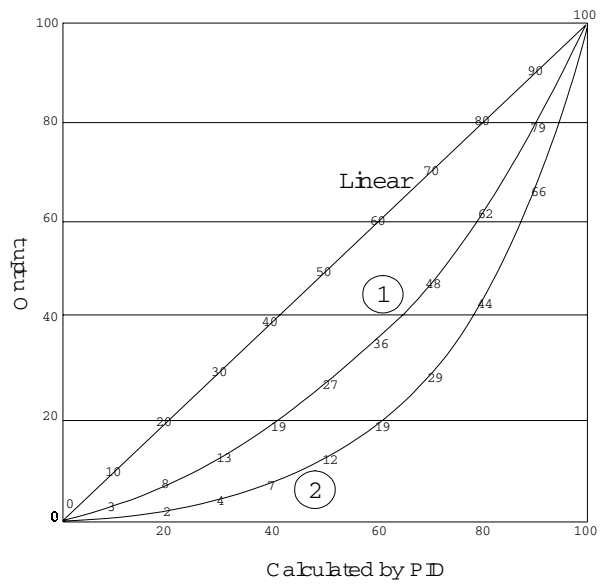

## Set up Loop Alarms

Press Yes at the Set up Loop Alarms prompt to access menus which change alarm function parameters for the current loop. The main alarms menu looks like this:

LOOP	PROCESS	UNITS
SETUP LOOP 04		
ALARMS ?		
ALARM SETPOINT	STATUS	OUT%

Below is the setup alarms menu tree.

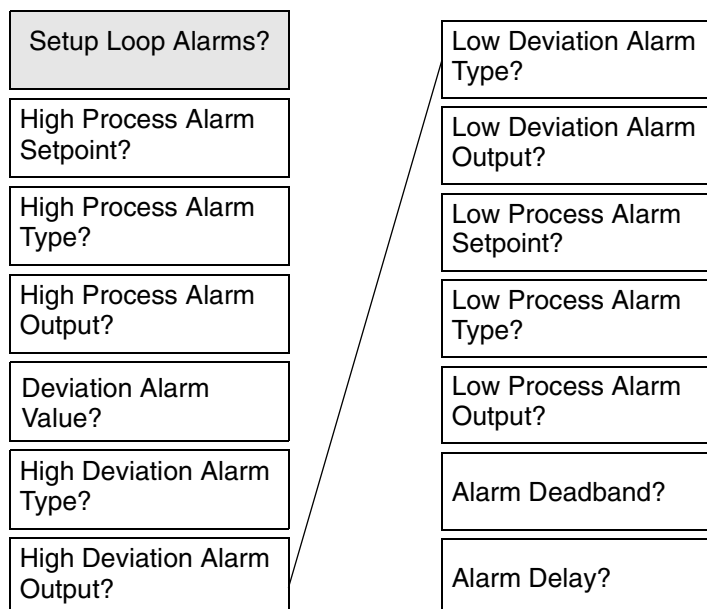

## Alarm Types

The CLS has three different kinds of alarms: failed sensor alarms, global alarms, and process alarms.

### *Failed Sensor Alarms*

Failed sensor alarms alert you to T/C breaks and these RTD open or short failures:

- Open + input.
- Open - input.
- Short between + and - input.

Failed sensor alarms alert you to T/C breaks. When the loop is in Automatic or Tune mode and a failed sensor alarm occurs, the CLS sets the loop to Manual control at the output override percentage you set in the Set up Loop Outputs menus.

### Global Alarms

Global alarms occur when a loop alarm set to Alarm (not Control) is unacknowledged, or when there are any unacknowledged failed sensor alarms. (If an alarm occurs, the CLS front panel displays an appropriate alarm code--see *Using the CLS section*.) Even if the alarm condition goes away, the global alarm stays on until you use the front panel **Alarm Ack** key (or ANASOFT) to acknowledge it.

### Process Alarms

Process alarms include high and low deviation and high and low process alarms. You can set each of these alarms to Off, Alarm, or Control, as shown here.

Function	Description
Off	No alarm or control function
Alarm	Standard alarm function
Control	Digital output activities on alarm, deactivates when loop is not in alarm. Global alarm output does not activate.

- High process and high deviation alarms activate when the process variable goes above a value you set. They remain active until the process variable goes below that value minus the deadband. (See the next diagram)
- Any digital output not used as a control output can be assigned to one or more process variable alarms. The output is active if any of its alarms are active. All alarm outputs are active Low or active High, depending on the global alarm output polarity setting.
- Low process and low deviation alarms activate when the process variable goes below a value you set. They remain active until the process variable goes above that value plus the deadband. (The next diagram shows these alarms.)

When the controller powers up or the setpoint changes, deviation alarms do not activate until the process goes inside the deviation alarm band, preventing deviation alarms during a cold start. (High and low process alarms are always enabled.)

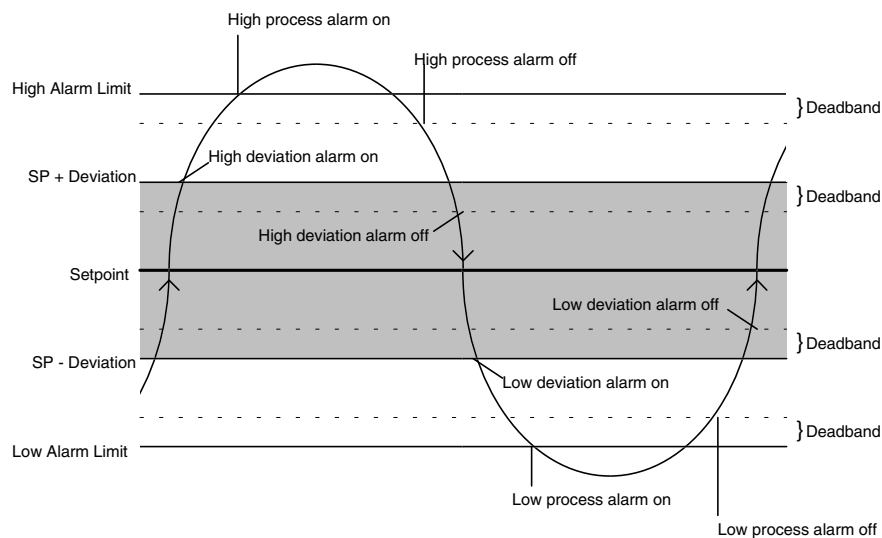

Use menus to set the following process alarm parameters for each loop:

- High and low process alarm type, setpoint, and digital output
- High and low deviation alarm type, deviation alarm value, and digital output
- Alarm deadband
- Alarm delay

The setpoints, deviation alarm values, and deadband all use the same decimal format as the loop's process variable.

### *Alarm Delay*

You can set the CLS to delay normal alarm detection and alarm reporting. There are two kinds of alarm delay:

- Start-up alarm delay delays process alarms (but not failed sensor alarms) for all loops for a time period you set in the Set up Global Parameters main menu.
- Loop alarm delay delays failed sensor alarms and process alarms for one loop until the alarm condition is continuously present for longer than the loop alarm delay time you set.



---

#### NOTE

**Failed sensor alarms are affected by the loop alarm delay even during the start-up alarm delay time period.**

---

## High Process Alarm Setpoint

Use this menu to select the setpoint (temperature or other value within the scaled sensor range) at which the high process alarm activates. The high process alarm activates when the process variable (PV) goes above the high process setpoint. It deactivates when the PV goes below the high process setpoint minus the deadband value, if you have set a deadband value.

LOOP	PROCESS	UNITS
04	HI PROC ALARM	
SETPT ?	1000	°F
ALARM SETPOINT	STATUS	OUT%

**Selectable range:** any point within the scaled sensor range.

## High Process Alarm Type

Use this menu to turn off the high process alarm or set it to the alarm or control function. (See the previous description for an explanation of these choices).

LOOP	PROCESS	UNITS
02	HI PROC ALARM	
TYPE ?	OFF	
ALARM SETPOINT	STATUS	OUT%

**Selectable values:** Off, Alarm, or Control.

## High Process Alarm Output Number

Use this menu to choose the digital output that activates when the loop is in high process alarm. You can use this output to activate a second alarm horn or buzzer. You can also use it to control your process. For example, you can set the output you have chosen to activate heating or cooling mechanisms, or to turn off the system.

LOOP	PROCESS	UNITS
01	HI PROC ALARM	
OUTPUT ?	NONE	
ALARM SETPOINT	STATUS	OUT%



---

### NOTE

**All digital outputs are OR'd together (combined). Therefore you can assign more than one alarm to the same output number, and that output will be On if any of those alarms is On.**

---

**Selectable values:** any output number between 1 and 34, as long as it's not already used for control or the SDAC clock, or you may select None.

## Deviation Band Value

Use this menu to set the deviation bandwidth, a positive and negative alarm or control point relative to the setpoint. If the setpoint changes, the alarm or control points also change. You can assign a separate digital output to the high and low deviation alarm/control setpoints--so that, for example, a high deviation alarm turns on a fan and a low deviation alarm turns on a heater.

LOOP	PROCESS	UNITS
02	DEV ALARM	
VALUE ?	5	°F
ALARM SETPOINT	STATUS	OUT%

**Selectable values:** 0-255, 25.5, 2.55, .255 or .0255, depending on the way you set up the Input menus.

## High Deviation Alarm Type

Use this menu to disable the high deviation alarm function or set it to the alarm or control function. (The high deviation alarm activates if the process value (PV) rises above the deviation band value, and remains active until the PV goes below the deviation band value minus the deadband value.)

LOOP	PROCESS	UNITS
03	HI DEV ALARM	
TYPE ?	OFF	
ALARM SETPOINT	STATUS	OUT%

**Selectable values:** Alarm, Control, Off

## High Deviation Alarm Output Number

Use this menu to assign a digital output which activates when the loop is in high deviation alarm. The digital output only activates if you have set the high deviation alarm type to Alarm or Control.

LOOP	PROCESS	UNITS
01	HI DEV ALARM	
OUTPUT ?	NONE	
ALARM SETPOINT	STATUS	OUT%



### NOTE

**All digital outputs are OR'd together (combined). Therefore you can assign more than one alarm to the same output number, and that output will be On if any of those alarms is On.**

**Selectable values:** Any output number between 1 and 34, as long as that output is not already used for control or the SDAC clock, or you may select None.

## Low Deviation Alarm Type

Use this menu to turn Off the low deviation alarm or set it to Alarm or Control mode.

LOOP	PROCESS	UNITS
01	LO DEV ALARM	
TYPE ? OFF		
ALARM SETPOINT	STATUS	OUT%

**Selectable values:** Off, Alarm, or Control.

## Low Deviation Alarm Output Number

Use this menu to assign a digital output that activates when the loop is in low deviation alarm.

LOOP	PROCESS	UNITS
04	LO DEV ALARM	
OUTPUT ? NONE		
ALARM SETPOINT	STATUS	OUT%



### NOTE

**All digital outputs are OR'd together (combined). Therefore you can assign more than one alarm to the same output number, and that output will be On if any of those alarms is On.**

**Selectable values:** 1 and 34, as long as that output is not already used for control or the SDAC clock, or you may select None.

## Low Process Alarm Setpoint

Use this menu to set a low process alarm setpoint. The low process alarm activates when the process variable goes below the low process alarm setpoint. It deactivates when the process variable goes above the low process alarm setpoint plus the deadband.

LOOP	PROCESS	UNITS
01	LO PROC ALARM	
SETPT ?	0	°F
ALARM SETPOINT	STATUS	OUT%

**Selectable range:** Any value within the input sensor's range.

## Low Process Alarm Type

This menu lets you turn off the low process alarm or set it to the Alarm or Control function.

LOOP	PROCESS	UNITS
02	LO PROC ALARM	
TYPE ? OFF		
ALARM SETPOINT	STATUS	OUT%

**Selectable values:** Off, Alarm or Control.

## Low Process Alarm Output Number

Use this menu to assign the digital output that activates when the loop is in low process alarm.

LOOP	PROCESS	UNITS
04	LO PROC ALARM	
OUTPUT ? NONE		
ALARM SETPOINT	STATUS	OUT%



### NOTE

**All digital outputs are OR'd together (combined). Therefore you can assign more than one alarm to the same output number, and that output will be On if any of those alarms is On.**

**Selectable values:** any from 1-34 that are not used for control or the SDAC clock.

## Alarm Deadband

Use this menu to set an alarm deadband. This deadband value applies to the high process, low process, high deviation, and low deviation alarms for the loop you are editing. Use the Alarm Deadband to avoid repeated alarms as the PV cycles slightly around an alarm value.

LOOP	PROCESS	UNITS
03	ALARM DEAD	
BAND ? 2 °C		
ALARM SETPOINT	STATUS	OUT%

**Selectable values:** 0 - 255, 25.5, 2.55, .255 or .0255, depending on the way you set up the Input menus.

## Alarm Delay

Use this menu to set a loop alarm delay. There are two types of alarm delay: the start-up alarm delay and loop alarm delay. Start-up alarm delay (which you can set in the **Set up Global Parameters** main menu) delays process alarms (but not failed sensor alarms) for all loops for a specified time after the controller powers up.

The loop alarm delay, in contrast, is set separately for each loop. It delays failed sensor and process alarms until the alarm condition has been continuously present for longer than the alarm delay time. (Failed sensor alarms are not subject to the start-up alarm delay, but they are affected by the loop's alarm delay during the start-up alarm delay period.)



**Selectable range:** 0-255 seconds.

## Manual I/O Test

Press Yes at this prompt to see menus which can help you test the digital inputs, digital outputs and the controller's keypad.

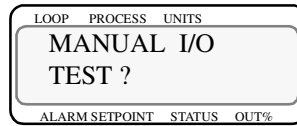

Below is the manual I/O menu tree.

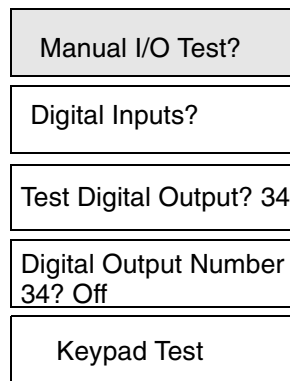

## Digital Input Testing

Use this menu to view the logic state of the 8 digital inputs as H (High--the input is at 5 volts or is not connected) or L (Low--the input is at zero volts). The menu displays inputs 1 to 8 from left to right. Since inputs are pulled High when they are not connected, test an input by shorting it to controller common and making sure this menu shows the correct state for that input.



### *Using This Menu*

- Short the digital input you are testing to controller common. When you do that, the input's state should change to L.
- Press **Yes** or **No** to advance to the next menu.
- Press **Back** to return to the Manual I/O test main menu.

## Test Digital Output

Use this menu to select one of the digital alarm outputs to test in the next menu.



## Toggle Digital Output

Use this menu to manually toggle a digital output On or Off to test it. (You select the output to test in the previous menu.) On may be Low or High depending on the digital output polarity you set in the Output Polarity menu. (All outputs are set to Off when you exit Manual I/O Test menu.)



**Selectable values:** On or Off.

## Keypad Test

Use this menu to test the keypad.

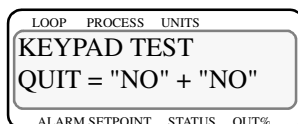

- Press any key to test the keypad. The CLS will display the name of the key you have pressed.
- Press **No** twice to advance to the next menu.

# PID Tuning and Control

## Introduction

---

This chapter explains PID control and supplies some starting PID values and tuning instructions, so that you can use control parameters appropriate for your system. If you would like more information on PID control, consult the Watlow Anafaze Practical Guide to PID.

The control mode dictates how the controller responds to an input signal. The control mode is different from the type of control output signal (like analog or pulsed DC voltage). There are several control modes available: On/Off, Proportional (P), Proportional and Integral (PI), Proportional with Derivative, and Proportional with Integral and Derivative (PID). P, PI, or PID control are necessary when process variable (PV) cycling is unacceptable or if the process or setpoint (SP) is variable.



---

### NOTE

**For any of these control modes to function, the loop must be in automatic mode.**

---

## Control Modes

The next sections explain the different modes you can use to control a loop.

### On/Off Control

On/Off control is the simplest way to control a process; a controller using On/Off control turns an output on or off when the process variable reaches a certain limit above or below the desired setpoint. You can adjust this limit, since Watlow Anafaze controllers use an adjustable spread. For example, if your setpoint is 1000 °F, and your limit (spread) is 20 °F, the output switches On when the process variable goes below 980 °F and Off when the process goes above 1000 °F. (The next diagram shows a process under On/Off control.)

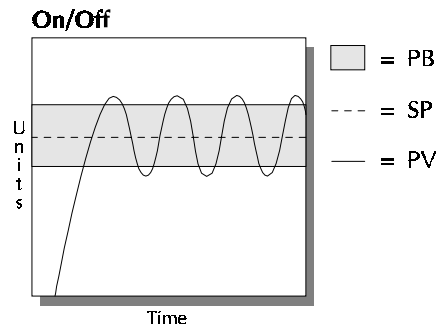

### Proportional Control

A process using On/Off control frequently cycles around the setpoint. When process variable cycling is unacceptable or the process or setpoint are variable, use proportional control. Proportional control, or Gain, eliminates cycling by increasing or decreasing the output proportional to the process variable's distance from the setpoint.

The limits of proportional control are defined by the Proportional Band (PB); outside this band of control, the output is either 100% or 0%. For example--using the same values from the example above and a PB of 20°---the output is:

- 50% when the process variable is 990 °F
- 75% when the process variable is 985 °F
- 100% when the process variable is 980 °F or below.

However, a process which uses only Proportional control may settle at a point above or below the setpoint; it may never reach the setpoint at all. This behavior is known as “offset” or “droop”. (This diagram shows a process under proportional control only.)

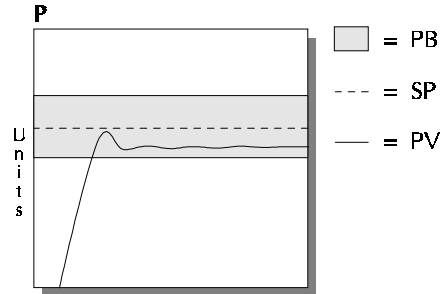

### Proportional and Integral Control

For Proportional and Integral control, use the Integral term, or Reset, with Proportional control. The Integral term corrects for offset by repeating the Proportional band's error correction until there is no error. For example, if a process tends to settle about 5 °F below the setpoint, use Integral control to bring it to the desired setting. (The next diagram shows a process under proportional and integral control.)

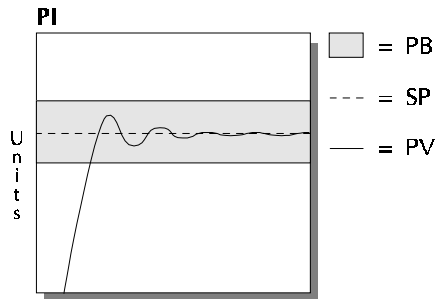

## Proportional, Integral and Derivative Control

For an improved level of control, use Derivative control with Proportional or Proportional and Integral control. Derivative control corrects for overshoot by anticipating the behavior of the process variable and adjusting the output appropriately. For example, if the process variable is rapidly approaching the setpoint, Derivative control reduces the output, anticipating that the process variable will reach setpoint. Use it to eliminate the process variable overshoot common to PI control. (This figure shows a process under full PID (Proportional, Integral, and Derivative) control).

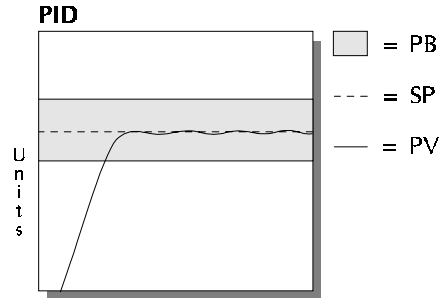

## Control Outputs

The CLS provides a 5 Vdc digital output signal for PID control outputs. These outputs normally control the process using relays. Watlow Anafaze can also provide a Serial Digital to Analog converter (SDAC) for 0-5 Vdc, 0-10 Vdc, or 4-20 mA analog output signals.

## Digital Output Control Forms

The next section explains different modes for control outputs.

### *On/Off*

On/Off output is very simple: it turns the output on or off according to the control signal of the On/Off control.

### *Time Proportioning (TP)*

Time Proportioning attempts to digitally simulate an analog output percentage by turning the output on or off for each time step so that the cumulative average of the output is the desired setting. You must enter a cycle time for TP outputs. The cycle time is the time over which the output is proportioned, and it can be any value from 1 to 255 seconds. For example, if the output is 30% and the Cycle Time is 10 seconds, then the output will be on for 3 seconds and off for seven seconds. The figure below shows typical TP and DZC graphs.

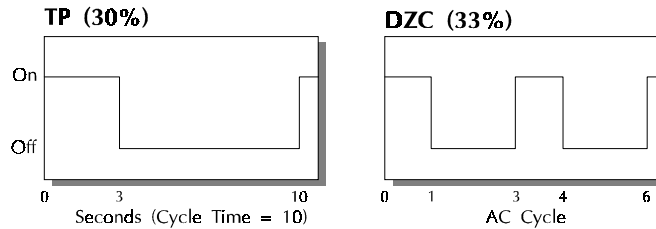

### *Distributed Zero Crossing (DZC)*

DZC output is essentially a Time Proportioning output. However, for each AC line cycle the controller decides whether the power should be On or Off. There is no Cycle Time since the decision is made for each line cycle. Since the time period for 60 Hz power is 16.6 ms, the switching interval is very short and the power is applied uniformly. Switching is done only at the zero crossing of the AC line, which helps reduce electrical “noise”.

DZC output is primarily used for very fast acting electrical heating loads using Solid State Relays (SSRs). For instance, the open air heater coil is an example of a fast acting load. Do not use DZC output for electromechanical relays.

The combination of DZC output and a solid state relay can inexpensively approach the effect of analog phase fired control.

### *Analog Outputs*

The Serial DAC is an optional analog output module for the CLS. It lets the controller output precision analog voltages or currents—typically for precision open-loop control, motor or belt speed control, or phase angle fired control. To use it, set the output type for the appropriate loop to SDAC.

### *Output Digital Filter*

The output filter digitally filters the PID control output signal. It has a range of 0-255 levels, which gives a time constant of 0-127.5 seconds. Use the output filter if you need to filter out erratic output swings due to extremely sensitive input signals, like a turbine flow signal or an open air thermocouple in a dry air gas oven.

The output filter can also enhance PID control. Some processes are very sensitive and require a high PB, so normal control methods are ineffective. You can use a smaller PB- and get better control- if you use the digital filter to reduce the high and low process output swings.

You can also use the filter to reduce output noise when a large derivative is necessary, or to make badly tuned PID loops and poorly designed processes behave properly.

### *Reverse and Direct Action*

Reverse action is an output control action in which an increase in the process variable causes a decrease in the output. Direct action is an output control action in which an increase in the process variable causes an increase in the output. Heating applications normally use reverse action and cooling applications usually use direct action.

## Setting Up and Tuning PID Loops

After you have installed your control system, tune each control loop and then set the loop to automatic control. (When you tune a loop, you choose PID parameters that will best control the process.) If you don't mind minor process fluctuations, you can tune the loop in automatic control mode. This section gives PID values for a variety of heating and cooling applications.

If you don't know the PID values that are best for your process, try the CLS Autotune feature. The autotune feature is accessible from the controller's Man/Auto key. (For more information about Autotune, see *Using the CLS*.)



### NOTE

**Tuning is a slow process. After you have adjusted a loop, allow about 20 minutes for the change to take effect.**

## Proportional Band (PB) Settings

The table below shows PB settings for various temperatures in degrees F.

Temperature Setpoint	PB	Temperature Setpoint	PB	Temperature Setpoint	PB
-100 to 99	20	1100 to 1199	75	2200 to 2299	135
100 to 199	20	1200 to 1299	80	2300 to 2399	140
200 to 299	30	1300 to 1399	85	2400 to 2499	145
300 to 399	35	1400 to 1499	90	2500 to 2599	150
400 to 499	40	1500 to 1599	95	2600 to 2699	155
500 to 599	45	1600 to 1699	100	2700 to 2799	160
600 to 699	50	1700 to 1799	105	2800 to 2899	165
700 to 799	55	1800 to 1899	110	2900 to 2999	170
800 to 899	60	1900 to 1999	120	3000 to 3099	175
900 to 999	65	2000 to 2099	125	3100 to 3199	180
1000 to 1099	70	2100 to 2199	130	3200 to 3299	185

As a general rule, set the PB to 10% of the setpoint below 1000° and 5% of the setpoint above 1000°. This setting is useful as a starting value.

## Integral Term (TI) Settings

This table shows TI settings vs. Reset settings.

TI (secs./repeat)	Reset (repeats/min)	TI (secs./repeat0	Reset (repeats/min)
30	2.0	210	0.28
45	1.3	240	.25
60	1.0	270	.22
90	.66	300	.20
120	.50	400	.15
150	.40	500	.12
180	.33	600	.10

As a general rule, use 60, 120, 180, or 240 as a starting value for the TI.

## Derivative Term (TD) Settings

This table shows Derivative term (TD) versus Rate Minutes (RM);  
Rate=TD/60.

TD (secs./repeat)	Rate (repeats/min)	TD (secs./repeat)	Rate (repeats/min)
5	.08	35	.58
10	.16	40	.66
15	.25	45	.75
20	.33	50	.83
25	.41	55	.91
30	.50	60	1.0

As a general rule, set the TD to 15% of TI as a starting value.

## General PID Constants by Application

This section gives PID values for many applications. They are useful as control values or as starting points for PID tuning.

### Proportional Band Only (P)

PB: Set the PB to 7% of the setpoint (SP) (Example: Setpoint = 450, so Proportional Band = 31).

### Proportional with Integral (PI)

PB: Set the PB to 10% of SP (Example: Setpoint = 450, so PB = 45).

Set TI to 60.  
Set TD to Off.  
Set the Output Filter to 2.

### PI with Derivative (PID)

PB: Set the PB to 10% of the SP (Example: Setpoint = 450, so PB = 45).

Set the TI to 60.  
Set the TD to 15% of the TI (Example: TI = 60, so TD = 9).  
Set the Output Filter to 2.

The next table shows general PID constants by application.

Application	PB	TI	TD	Filter	Output Type	Cycle Time	Action
Electrical heat w/ SSR	50°	60	15	4	TP	3	Reverse
Electrical heat w/ EM relays	50°	60	15	6	TP	20	Reverse
Cool w/ solenoid valve	70°	500	90	4	TP	10	Direct
Cool w/ fans	10°	off	10	4	TP	10	Direct
Electric heat w/ open heat coils	30°	20	off	4	DZC	-	Reverse
Gas heat w/ motorized valves SP>1200	60° 100	120 240	25 40	8	DAC or SDAC	-	Reverse
Electric heat w/ phase angle controlled SCR	60°	60	15	4	DAC or SDAC	-	Reverse
Extuders w/ cooling gas heat w/ SSR (set spread to 8)	50°	300	120	4	TP	3	Reverse



# Troubleshooting

The next few sections describe general troubleshooting for the CLS. Later sections describe specific procedures, like checking an input, changing the EPROM, and testing the controller.

## *First, Check your Installation*

Please bear in mind that, even in stand-alone systems, the controller is only part of your control system. Often, what appears to be a problem with the CLS is really a problem with other equipment- so check these things first:

- Controller is installed correctly. (See *Installation* for help.)
- Inputs — like thermocouples and RTDs — are installed correctly, and they're working.

## *Second, Replace Unit*

If you are certain that the controller is installed correctly, you can try replacing the CLS with a spare CLS. If the spare unit works correctly, then the problem is specific to the CLS you replaced.



---

### WARNING

**If the controller wasn't installed correctly--for instance, if you have shorted sensor inputs to high voltage lines or a transformer is shorted out--and you replace the CLS with a spare unit, the spare unit will break, and you'll need to send both units to Watlow Anafaze for repair. Therefore, make sure you have checked the installation before replacing the controller.**

---

If you need to update the CLS Erasable Programmable Read-Only Memory (EPROM), please refer to the third section in this chapter, Changing the EPROM.

## No Key Reset

If the instructions in this manual tell you to perform a “No Key Reset”, please do the following:

1. Power down the unit.
2. Press and hold the No key on the front panel. Power up the unit.



---

#### NOTE

**A No key reset clears the CLS memory and resets its parameters to their default values. If you have a stand-alone system, there is no way to recover your original parameters. If you have a computer-supervised system with ANASOFT, ANASOFT can store a copy of your parameters to a job file.**

---



---

#### WARNING

**Do not attempt to repair the controller yourself. If the troubleshooting procedures in this chapter do not solve your system's problems, call the Technical Services department for additional troubleshooting help. If you need to return the unit to Watlow Anafaze for testing and repair, Technical Services will issue you an RMA number- see Returning the Unit below.**

---

### Returning your Unit

If you need to return the CLS, please contact Watlow by phone, fax or e-mail (see contact information on cover) for a Returned Materials Authorization (RMA) number. The RMA number helps us track your equipment and return it to you as soon as possible.

---

## Troubleshooting Stand-Alone Systems

The CLS is only part of a control system; be sure to check other parts of the system, like thermocouples, before you assume that the unit is broken. To check inputs and outputs, follow these procedures.

### Checking an Analog Input

To check any input except the pulse input, follow these steps:

1. Disconnect the sensor wiring.
2. Set the input sensor to type J T/C from the Setup menus.
3. Place a short across the input.

The process variable should indicate ambient temperature. If it does not, call Watlow Anafaze for an RMA number and return the unit for repair.

To check thermocouple inputs, remove the thermocouple leads and use an ohm meter to measure between the In+ and In- terminals of TB1. Thermocouple inputs should not read above 200 ohms.

To check RTD inputs, measure between the In+ and In- terminals of TB1. RTD inputs should read between 20 and 250 ohms.

## Checking Digital I/O

The following steps will help you test digital inputs and outputs.

### *TB-18 and TB-50 Test*

1. Plug in the CLS power supply, if you have not already done so.
2. Measure the +5Vdc supply at your TB-18 or TB-50:
  - A. Connect the voltmeter's Common lead to your TB-18 screw terminal #2 or TB-50 screw terminal #3.
  - B. Connect the voltmeter's Power lead to your TB-18 or TB-50 screw terminal #1. The voltage should be 4.75 to 5.25 Vdc.

### *Control and Digital Output Testing*

1. Connect a 500 ohm to 100 Kohm resistor between the +5V pin (TB-18 or TB-50 screw terminal #1) and the output pin you want to test.
2. Connect the Common lead to the output pin.
3. Connect the voltmeter positive lead to the +5V pin.
4. If you are testing a PID control output, use the Man/Auto front panel key to turn the output on (100%) and off (0%). When the output is off, the output voltage should be less than 1V. When the output is on, the output voltage should be between 3.75 and 5.5V.
5. If you are testing a digital output, use the Manual I/O Test menu to turn the output on and off. (See **Setup** for information on the Manual I/O Test menu.)

### *Digital Input Testing*

1. Go to the digital input test menu (under the Manual I/O Test main menu). This menu shows whether the digital inputs are H (high, or open) or L (Low, or closed).
2. Attach a wire to the terminal of the digital input you want to test.
  - A. When the wire is connected only to the digital input terminal, the digital input test menu should show that the input is H (High, or open).
  - B. When you connect the wire to logic ground (TB-18 pin #2; TB-50 pin #3), the digital input test menu should show that the input is L (Low, or closed).

---

## Checking Computer Supervised Systems

Four elements must work properly in a computer supervised system that uses an IBM-compatible computer and ANASOFT:

- The CLS.
- The computer and its RS-232 or RS-485 serial interface.
- The RS-232 or RS-485 communications line.
- The computer's software.

For CLS troubleshooting, disconnect the communications line from the computer before you follow the troubleshooting steps explained in the previous sections. Troubleshooting for the computer and communications are explained in the sections below.

### Computer Problems

If you are having computer or serial interface problems, check the following:

- Make sure you are using DOS 5.0 or a later version of DOS.
- Check the communications interface, cables, and connections. Make sure the serial interface is set according to the manufacturer's instructions.
  - To test an RS-232 interface, buy an RS-232 troubleshooter from Radio Shack or an equivalent supplier. Attach the troubleshooter between the CLS and the computer. When ANASOFT sends data to the CLS, the troubleshooter's TX LED should blink. When ANASOFT receives data from the CLS, the RX LED should blink.
  - You can also connect an oscilloscope to the transmit or receive line to see whether data is being sent or received. If the serial interface does not function, contact your computer service representative.



---

#### NOTE

**Most communications problems are due to incorrect wiring or incorrectly set communications parameters. Therefore, check the wiring and communications settings first.**

---

If you have more than one controller, or you are using more than 50 feet of communications wiring, you must use RS-485 communications. Otherwise, you can use RS-232 communications. The CLS is configured for RS-232 communications when it is shipped. If you are using RS-485 communications, you must set the internal RS232/RS485 selection jumpers to the correct position. (See Chapter 2: Installation for information about changing jumpers.)

From the setup menus, make sure that the communications parameters (address, error checking and baud rate) are set correctly for each CLS in your system.

Every controller must have a separate address, starting with 1 and increasing by 1 for each controller.

The error checking method and baud rate must be set the same way in the controller's setup menus and in ANASOFT.

### *Ground Loops*

On some computers, the RS-232 common wire is tied to earth ground. Since the CLS ground is also tied to earth ground, this arrangement creates a ground loop which may affect communications and other CLS functions. To avoid ground loops, either use an optically isolated communications adapter or disconnect the CLS from earth ground and tie a .1  $\mu$ F capacitor from CLS DC common to earth ground.

## Software Problems

### *ANASOFT*

Consult the ANASOFT User's Guide for help with ANASOFT.

### *User-Written Software*

If you don't want to use ANASOFT as your software interface to the CLS, you are responsible for the correct operation of the software you buy or write. You can request technical documentation from Watlow Anafaze if you want to write your own software. Watlow Anafaze will answer any technical questions that arise during your software development process, but Watlow Anafaze does not otherwise support user software in any way.

## Changing the EPROM

Changing the EPROM involves minor mechanical disassembly and reassembly of the controller, but you don't need any soldering or electrical expertise. The only tools you need are a Phillips head screwdriver and a small flathead screwdriver.



---

### NOTE

**If you change the EPROM, you must perform a No Key Reset for the EPROM change to take effect. A No Key Reset changes all controller parameters back to their default values, so you must reenter the desired values from ANASOFT or from the controller front panel after you change the EPROM.**

---

1. **Power down the controller.** Be sure to take antistatic precautions.

2. Remove the two screws from the sides of the controller front panel.

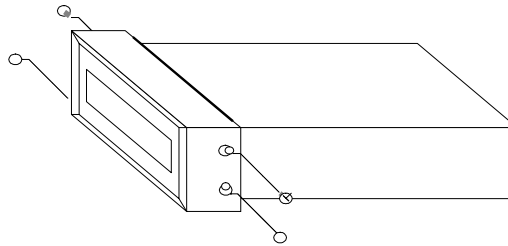

3. Remove the electronics assembly from the case, as shown below.

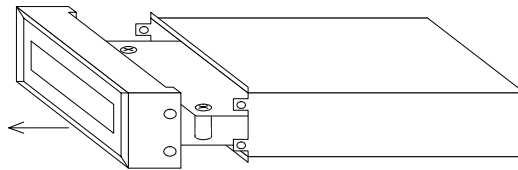

4. Unscrew the four screws at the corners of the top board and carefully unplug this board to access the bottom board (processor board), as shown below.

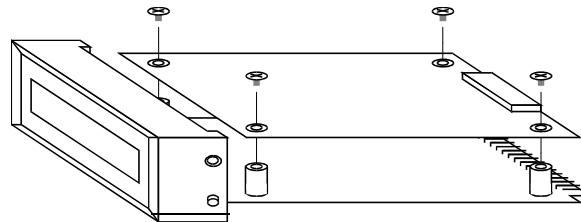

5. Find the installed EPROM. This is a 28 pin socketed chip which should have an Anafaze label on top of it. (If there is no label, a small window will be visible in the middle of the top of the chip.) Do not confuse the EPROM with the RAM; the RAM also has 28 pins, but it's in high profile socket, and it does not have a label or a window. (The component designation U2 is printed on the processor board next to the EPROM socket.) The next figure shows the EPROM and RAM chip.

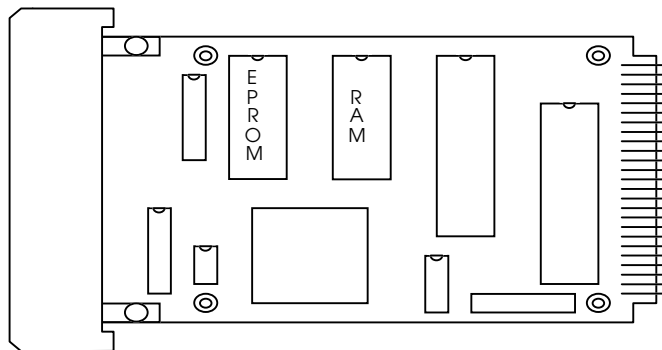

6. Remove the existing EPROM from its socket by prying it out with a small flathead screwdriver, as shown below.

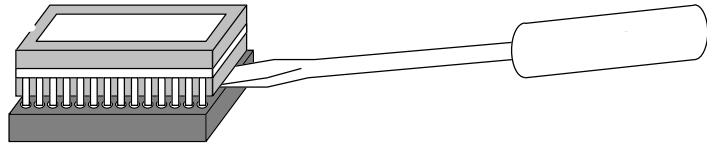

7. The EPROM is shipped with its legs bent at an angle that best fits its packaging. Bend the legs slightly so that the legs line up with the holes in the EPROM socket. Don't try to bend the legs one at a time; instead, gently press the legs against a flat surface until they're at a 90-degree angle to the EPROM body, as shown below.

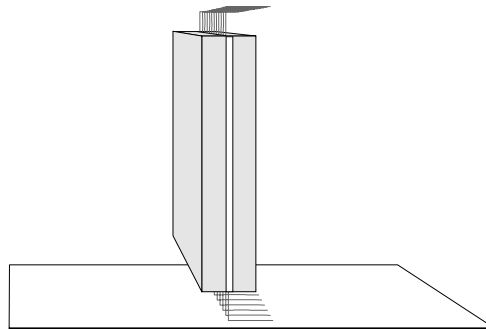

8. Carefully insert the new EPROM into the EPROM socket. Make sure that the chip is oriented so that its notch faces the same way as the part outline on the board.
9. Reverse steps 2 through 4 to reassemble the unit.
10. Do a No key reset to reinitialize the battery backed RAM. You must perform a No key reset for the unit to operate properly. (To do a No key reset, power down the controller. Then press the No key and power up the controller.)



# Linear Scaling Examples

## Example 1

### Situation

A pressure sensor that generates a 4-20 milliamp signal is connected to the CLS. The specifications of the sensor state that it generates 4 milliamps at 0.0 PSI and 20 mA at 50.0 PSI.

### Setup

The sensor is connected to a loop input set up with a resistor scaling network to produce 60 millivolts at 20 mA. (See the **Inputs** section of *Installation* for more information on scaling networks.)

The sensor measures PSI in tenths, so the appropriate display format is -999.9 to +3000.0.

This table shows the input readings.

PV Displayed	Sensor Input	Reading (%FS)
50.0 PSI	20	100%
0.0 PSI	4	$100\% \times (4\text{ma}/20\text{ ma}) = 20\%$

The scaling values are therefore:

Parameter	Low Value	High Value
Process Value (PV)	0.0 PSI	50.0 PSI
Input Reading (RDG)	20.0	100.0

## Example 2

### *Situation*

A flow sensor connected to the CLS measures the flow in a pipe. The sensor generates a 0-5V signal. The sensor's output depends on its installation. Independent calibration measurements of the flow in the pipe indicate that the sensor generates 0.5 volts at three gallons per minute (GPM) and 4.75 volts at 65 GPM. The calibration instruments are precise to  $\pm 1$  gallon per minute.

### *Setup*

The sensor is connected to a loop input set up with a resistor voltage divider network to produce 60 millivolts at 5 volts. (See the **Inputs** section of the *Installation* chapter for information on scaling networks.)

The calibrating instrument is precise to  $\pm 1$  gallon per minute, so the appropriate display format is -999 to +3000.

This table shows the input readings.

PV Displayed	Sensor Input	Reading (%FS)
65 GPM	4.75	$(4.75V / 5.00V) \times 100\% = 95\%$
3 GPM	0.5	$(0.5V / 5.00V) \times 100\% = 10\%$

The scaling values are therefore:

Parameter	Low Value	High Value
Process Value (PV)	3 GPM	65 GPM
Input Reading (RDG)	10.0	95.0

## Example 3

---

### *Situation*

A pulse encoder which measures the movement of a conveyor is connected to the CLS. The encoder generates 900 pulses for every inch the conveyor moves. You want to measure conveyor speed in feet per minute (f/m).

### *Setup*

The encoder input is connected to the CLS' pulse input. An one second sample time gives adequate resolution of the conveyor's speed.

The resolution is:

$$\frac{1 \text{ pulse}}{1 \text{ second}} \times \frac{60 \text{ seconds}}{1 \text{ minute}} \times \frac{1 \text{ inch}}{900 \text{ pulses}} \times \frac{1 \text{ foot}}{12 \text{ inches}} = 0.006 \text{ f/m}$$

So a display format of -99.99 to +300.00 is appropriate.

The input readings are as follows.

**At the maximum pulse rate of the CLS (2000 Hz):**

$$\frac{2000 \text{ pulses}}{1 \text{ second}} \times \frac{60 \text{ seconds}}{1 \text{ minute}} \times \frac{1 \text{ inch}}{900 \text{ pulses}} \times \frac{1 \text{ foot}}{12 \text{ inches}} = 11.11 \text{ f/m}$$

**At zero hertz, the input reading will be 0.00 f/m.**

Therefore, the scaling values are:

Parameter	Low Value	High Value
Process Value (PV)	0 f/m	11.11 f/m
Input Reading (RDG)	0 Hz	2000 Hz



# Appendix A: Ramp Soak

---

## Introduction

This Appendix will teach you how to set up and use Ramp/Soak profiles in CLS controllers.

The Ramp/Soak feature turns your controller into a powerful and flexible batch controller. Ramp/Soak lets you program the controller to change a process setpoint in a preset pattern over time. This preset pattern, or temperature **profile**, consists of several **segments**. During a segment, the temperature goes from the previous segment's setpoint to the current segment's setpoint.

- If the current segment's setpoint is larger or smaller than the previous segment's setpoint, it is called a **ramp** segment.
- If the current segment's setpoint is the same as the previous segment's setpoint, it is called a **soak** segment.

Each segment can have up to two **triggers**. At least one of these two triggers must be true before the segment can start. While the input is not true, the profile waits (this wait state is called **trigger wait**).

You can use any one of the eight digital inputs for triggers. You can also use the same trigger for more than one segment or more than one profile.

Each segment can also have up to four **events** (external signals connected to the digital outputs). Events occur at the end of a segment. You can use any of the digital outputs that are not used for control or for the SDAC clock for events.

## R/S Features

- **User-configurable time base:** Watlow Anafaze's Ramp/Soak lets you set your profiles to run for hours and minutes or for minutes and seconds—Whichever is appropriate for your installation.
- **Repeatable profiles:** You can set any profile to repeat from 1 to 99 times or continuously.
- **Fast setup for similar profiles:** You can set up one profile, then copy it and alter it to set up the rest.
- **External reset:** Use the CLS external reset menu to configure a digital input you can use to reset a profile to the Ready state.

## Specifications

Number of possible profiles	17
Number of times to repeat a profile	1-99 or continuous
Number of segments per profile	1-20
Number of triggers per segment	Up to 2
Type of triggers	Latched/ Unlatched
Number of possible inputs for triggers	8
Number of events per segment	4
Number of possible outputs for events (At least one of these outputs must be used for control)	34

## Configuring Ramp/Soak

This section will teach you how to set up R/S profiles. The following diagram shows the R/S configuration menu tree.

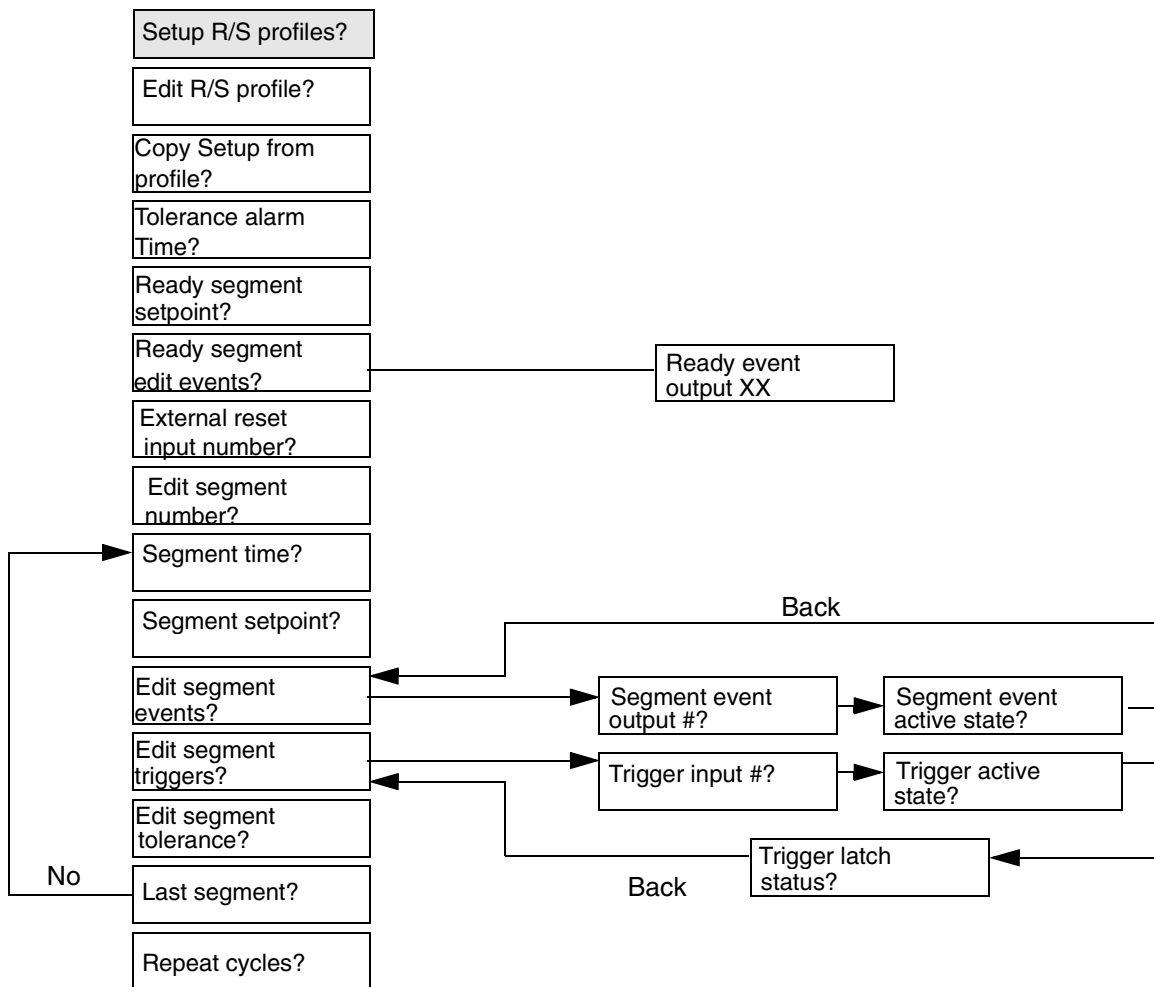

## Setting the R/S Time Base

The R/S time base menu is in the Setup Globals main menu.

Use this menu to set the time base in all your R/S profiles.



**Selectable Values:** Hours/Mins or Mins/Secs.

## Editing R/S Parameters

You can reach the rest of the menus in this section from the Setup Ramp/Soak profile main menu. This menu is located between the Setup Loop Alarms main menu and the Manual I/O Test main menu.



Answering Yes to this prompt allows you to setup or edit R/S profiles.

## Choosing a Profile to Edit

Use this menu to choose a profile to set up or edit.



**Selectable Values:** A to Q (17 profiles).

## Copying the Setup from Another Profile

Use this menu to setup similar profiles quickly, by copying a profile to another one.

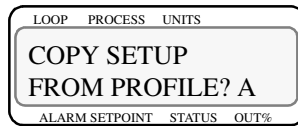

**Selectable Values:** A to Q.

## Editing the tolerance Alarm Time

Use this menu to set a tolerance time that applies to the entire profile.



When the segment goes out of tolerance,

- The segment goes into tolerance hold
- The segment timer holds
- The loop's single loop display shows TOHO (Tolerance Hold)

When the segment has been out of tolerance for more than the tolerance alarm time,

- The controller goes into tolerance alarm
- The tolerance timer resets

You must acknowledge the tolerance alarm by pressing the ALARM ACK key before you can do any other editing.

**Selectable Values:** 0:00 to 99:59 (minutes or hours, depending on the time base setting).

## Editing the Ready Setpoint

When you assign a profile to a loop, the profile doesn't start immediately; instead, it goes to the ready segment (segment 0) and stays there until you put the profile in Start mode.

You can set a setpoint, assign events, and set event states for the ready segment. Use this menu to set the ready segment setpoint.



**Selectable Values:** -999 to 9999, or Off.

## Editing the Ready Event States

Use this menu to set the ready state for all outputs that are not used for control or for the SDAC clock. When you assign a profile, the controller starts the ready segment: it goes to the ready setpoint and puts all the outputs in the ready state you set here. The outputs stay in the ready state until the end of segment 1, when segment 1's events become active.



When you press NO, you will advance to the next menu. If you press YES, this menu appears:



**Selectable Values:** You can toggle inputs that are not IN USE to On or Off.

## Choosing an External Reset Input

Use this menu to select an external reset input. Toggle the input to reset a profile to Ready state when it is in Run, Hold, or Wait mode. You can make any of the eight digital inputs the external reset input.

LOOP	PROCESS	UNITS
C EXTERNAL RESET		
INPUT NUMBER ? N		
ALARM SETPOINT	STATUS	OUT%

**Selectable Values:** 1-8, or N (for no external reset).

## Editing a Segment

Each profile is made up of several segments (up to 20). Use this menu to choose the segment to edit.

LOOP	PROCESS	UNITS
D EDIT SEGMENT		
NUMBER ? 15		
ALARM SETPOINT	STATUS	OUT%

**Selectable Values:** 1-20.

The first time you use this menu, it defaults to segment 1. when you have finished editing a segment, the controller returns you to this menu and goes to the next segment. This loop continues until you make a segment the last segment of a profile.

## Setting Segment Time

Use this menu to change the segment time.

LOOP	PROCESS	UNITS
B SEGMENT 11		
SEG TIME? 000:00		
ALARM SETPOINT	STATUS	OUT%

**Selectable Values:** 000:00 to 999:59 (minutes or seconds, depending on the selected time base).

## Setting a Segment Setpoint

Use this menu to set a setpoint for the segment you are editing. The process will go to this setpoint by the end of the segment time.

LOOP	PROCESS	UNITS
C	SEGMENT	5
SEG SETPT ? OFF		
ALARM SETPOINT	STATUS	OUT%

**Selectable Values:** -999 to 9999, or Off (no segment setpoint).

## Configuring Segment Events

You can assign up to four digital outputs—**Events**—to each segment. When the segment ends, the events you select go to the output state you specify. Use this menu to select events and specify their output states.

LOOP	PROCESS	UNITS
A	SEGMENT	5
EDIT SEG EVENTS?		
ALARM SETPOINT	STATUS	OUT%

**Selectable Values:** YES or NO.

### *Starting a segment with an event*

If you want a segment to start with an event (usually events happen at the end of the segment), program the previous segment for the event. You can also use this trick:

1. Setup the segments that come before the first segment.
2. Setup an extra segment with time 000:00 and with the events for the first segment.
3. Setup the first segment.

If you also want to have events at the end of the segment, or you want the event to go off at the end of the segment, setup the first segment with the desired event number and event output state.

## Editing Event Outputs

This menu appears only if you answered YES to the previous menu. Use it to assign a digital output to each event. Assign digital outputs that are not being used for PID control or for SDAC clock.

LOOP	PROCESS	UNITS
A	SEG 20	EVENT 3
OUTPUT #? 30		
ALARM SETPOINT	STATUS	OUT%

**Selectable Values:** Any digital output from 1 to 34, except those IN USE, or None (no event).

## Changing Event States

Use this menu to assign an output state to each event: On (High) or Off (Low). When the event occurs, the output goes to the state you assign here.

LOOP	PROCESS	UNITS
A	SEG14	EV3 DO 4
OUTPUT STATE? OFF		
ALARM SETPOINT	STATUS	OUT%

**Selectable Values:** Off (Low) or On (High).

## Editing Segment Triggers

Each segment has two triggers (digital inputs). One of these triggers must be true before the segment can begin. If a segment times out and at least one of the next segment's triggers is not true, the profile goes into trigger wait state.

Use this menu to edit triggers for the current segment.

LOOP	PROCESS	UNITS
C	SEGMENT	15
EDIT SEG TRGGRS?		
ALARM SETPOINT	STATUS	OUT%

**Selectable Values:** YES (to edit triggers of current segment), or NO (to advance to the Edit Segment Tolerance menu).

## Assigning an Input to a Trigger

This menu appears only if you answered YES to the Edit Segment Triggers menu. Use it to assign one of the controller's eight digital inputs to a segment trigger. You can assign any digital input to any trigger. You can also assign the same digital input to multiple triggers.

LOOP	PROCESS	UNITS
C	SEG18	TRIG1
INPUT NR ?NONE		
ALARM SETPOINT	STATUS	OUT%

**Selectable Values:** Any digital input from 1-8, or None (no input assigned). Setting a trigger to None disables it.

## Changing a Trigger's True State

Use this menu to toggle a trigger's true state On or Off. This menu appears only if you answered YES to the Edit Segment triggers menu.

LOOP	PROCESS	UNITS
C	SEG03	TR2DI09
ACTIVE STATE? OFF		
ALARM SETPOINT	STATUS	OUT%

**Selectable Values:** Off or On.

## Latching or Unlatching a Trigger

Use this menu to make a trigger latched or unlatched.

- A latched trigger is checked once, at the beginning of a segment.
- An unlatched trigger is checked constantly while a segment is running. If an unlatched trigger becomes false, the segment timer stops and the loop goes into trigger wait state.

LOOP	PROCESS	UNITS
B	SEG01	TR2 DI08
TRIG ? UNLATCHED		
ALARM SETPOINT	STATUS	OUT%

**Selectable Values:** Latched or Unlatched.

## Setting Segment Tolerance

Use this menu to set a positive or negative tolerance value for each segment. this value is displayed in the engineering units of the process and is a deviation from the setpoint.

Tolerance works as shown in this diagram:

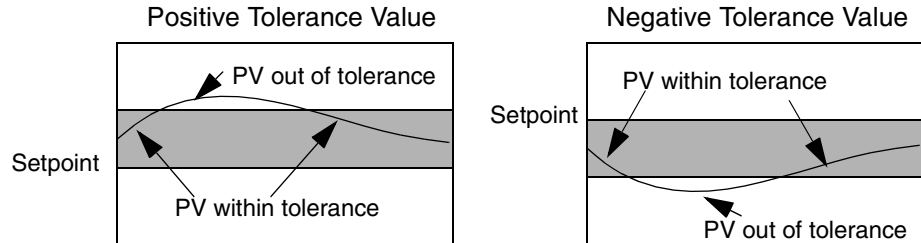

If you enter a positive tolerance, the process is out of tolerance when the PV goes above the setpoint plus the tolerance.

If you enter a negative tolerance, the process goes out of tolerance when the PV goes below the setpoint minus the tolerance.



**Selectable Values:** -99 to 99, or Off (no tolerance).

## Ending a Profile

Use this menu to make a segment the last one in the profile.



**Selectable Values:** No or Yes.

## Repeating a Profile

Use this menu to set the number of times you want a profile to repeat or cycle.

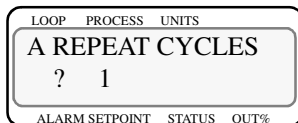

**Selectable Values:** 1-99, or C (continuous cycling).

## Using Ramp/Soak

This section explains how to assign a profile to a loop, how to put a profile in Run, Continue, or Hold mode, how to reset a profile, and how to display profile statistics.

The next figure shows the Ramp/Soak key menus.

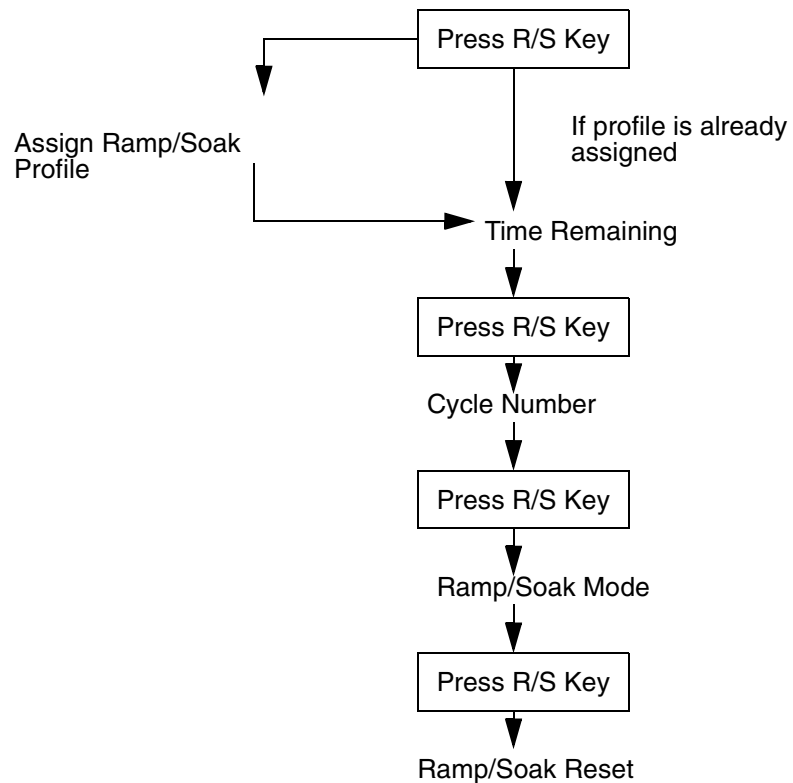

From the Ramp/Soak Reset display:

- Press NO to return to Single Loop display.
- Press BACK to return to the Time Remaining display.

### Assigning a profile to a loop

Use this menu to assign a profile to a loop.



#### *Assigning a profile the first time*

To assign a profile to a loop that doesn't have a profile, follow these steps:

1. In Single Loop display, switch to the loop you want to edit.
2. Press the RAMP/SOAK key. The assigning menu appears. (See menu in previous page)
3. Choose one of the available profiles and press ENTER.
4. Press BACK if you wish to return to Single Loop display without saving any changes.

### *Assigning a different profile*

To assign a new profile to a loop that already has one assigned, follow these steps:

1. Press the RAMP/SOAK key three times.
2. Press the NO key. You will see the Reset Profile menu.
3. Press YES, then ENTER, to reset the profile. You will see the Assign Profile menu. (See previous page.)
4. Choose one of the available profiles and press ENTER.
5. Press BACK if you wish to return to Single Loop display without saving any changes.

## Assigning a Profile to a Linear Input Loop

If you assign a profile to a loop with a linear input, these variables will depend on the display format setting you chose for the linear input:

- Ready setpoint
- Segment setpoint
- Segment tolerance

Before you assign a profile to a linear input loop, Consult the following table.

Display Format setting	Effect on Parameter
-999 to 3000	Parameter is as set in profile.
-9999 to 30000	Controller multiplies your parameter by ten.
-999.9 to 3000.0	Controller adds a decimal point and a zero to your parameter.
-99.9 to 300.0	Controller divides your parameter by ten.
-9.999 to 30.000	Controller divides your parameter by 100.
0.999 to 3.00	Controller divides your parameter by 1000.

## Running a Profile

When you assign a profile, it does not start running immediately; instead, the loop enters the Ready segment (segment 0). Use this menu to start a profile (put it in Start mode).

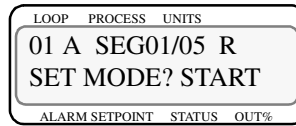

### *Starting a profile*

You can start a profile only when it's in the Ready segment.

1. Press the RAMP/SOAK key repeatedly until you see the Ramp/Soak mode menu.
2. While the profile is in Ready segment, the only mode available is the Run mode.
3. Press YES to start the profile, and then ENTER to advance to the next menu.

### *Running several profiles simultaneously*

To run several profiles simultaneously, follow these steps:

1. Setup the profiles so that segment 1 of each profile has the same latched trigger.
2. Assign the profiles to the appropriate loops. The loops will go to the Ready segment of each profile.
3. Set each profile to Run mode.
4. Trip the trigger.

### *Editing a profile while it is running*

You can edit a profile while it is running, but the changes you have made will not take effect until the next time it runs.

## Ramp/Soak Displays

The Single loop and Bar Graph displays show additional codes for R/S controllers.

### *Single loop display*

When the controller is running a profile, the Single Loop display shows the profile mode where it would usually show MAN or AUTO. The next table shows the available codes and their meaning.

Code	Mode
STRT	The profile is in the Ready segment.
RUN	The profile is running.
HOLD	The user has put the profile in Hold mode.
TOHO	The profile is in tolerance hold.
WAIT	The profile is in trigger wait state.

This is the Single Loop display when a profile is running.

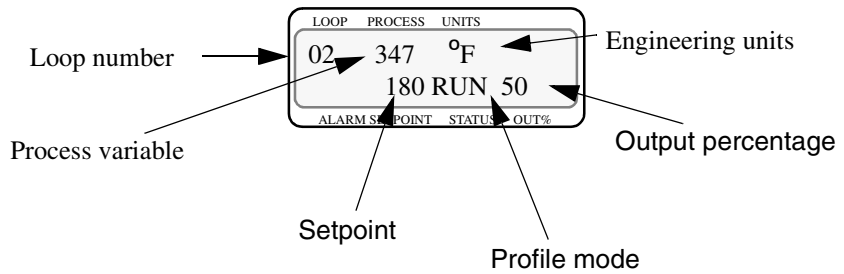

### Bar graph display

Loops that are running R/S profiles have different Bar Graph display codes. For these loops, you will see the first letter of each mode where the controller would normally display M (for Manual control) or A (for Automatic control).

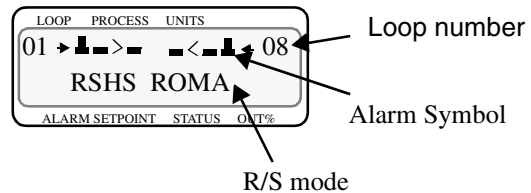

The next table shows the codes you would see in loops running R/S profiles.

Code	Meaning
R	A profile is running.
H	A profile is holding.
S	A profile is in Ready state.
O	A profile is in tolerance hold.

### Ramp/Soak Key Displays

Use the RAMP/SOAK key to see the time left in the current profile, the profile's status, or the number of times the profile has cycled.

All the menus you can reach from the RAMP/SOAK key have the same information on the top line.

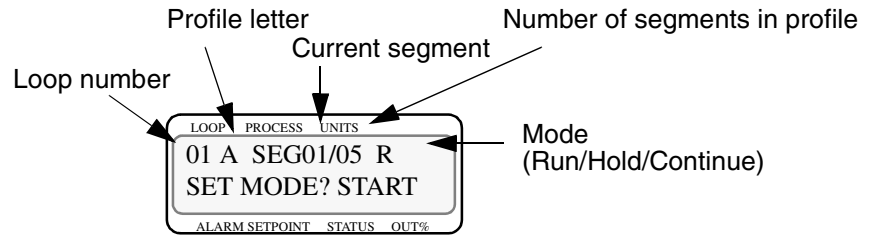

### *How long has the profile run?*

From Single Loop display, press the RAMP/SOAK key **once**.

The next menu appears only if you have already assigned a profile to the loop.

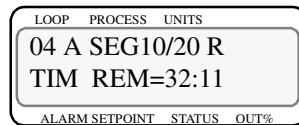

### *How many times has it cycled?*

From Single Loop display, press the RAMP/SOAK key **twice**. The next menu will appear. This menu displays the number of times the profile has run out of the total number of cycles.

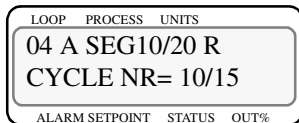

## Holding a Profile or Continuing from Hold

Use the profile mode menu to hold a profile or continue from Hold. The next table shows the available modes.

Current Mode	Available Mode	Description
Start	Run	Begin running the assigned profile.
Hold	Cont	Continue from user-selected hold. Profile runs from the point when you put the profile in Hold mode. (You cannot continue from a tolerance hold or a trigger wait.)  After you choose this mode, the controller switches back to Run mode.
Run	Hold	Hold the profile.

### *Holding a profile*

In Hold mode, all loop parameters stay at their current settings until you change the mode or reset the profile. To put a profile in hold, follow these steps:

- Press RAMP/SOAK key repeatedly until you see the R/S mode menu.



- While the profile is running, the only mode you will be able select is Hold.
- Press YES to hold the profile, and then ENTER to advance to the next menu.

### *Continuing a profile*

If a profile is holding and you want it to run, you can put it in Continue mode.

- Press RAMP/SOAK key repeatedly until you see the R/S mode menu
- While the profile is holding, the only mode you will be able select is Cont (Continue).
- Press YES to continue the profile, and then ENTER to advance to the next menu.

## Resetting a profile

Use this menu to reset a profile. When you reset a profile, the following happens:

- The profile returns to the ready segment. The PV goes to the ready setpoint, and the ready segment events go to the state you specified in the Edit Ready Event State menu.
- The controller shows you the Assign Profile menu in case you would like to assign a different profile to the loop.

To reset a profile, follow these steps:

1. Press RAMP/SOAK key repeatedly until you see the R/S mode menu
2. Press the NO key. You should see the menu below.
3. Press YES to reset the profile, and then ENTER to confirm your choice.:

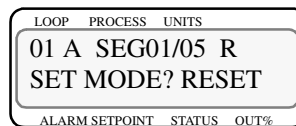



# ***Appendix B: Enhanced Process Control***

This Appendix explains five new features added to the CLS and MLS controllers:

- Process Variable Retransmit
- Cascade Control
- Ratio Control
- Remote Analog Setpoint
- Differential Control

## Enhanced Process Control Menus

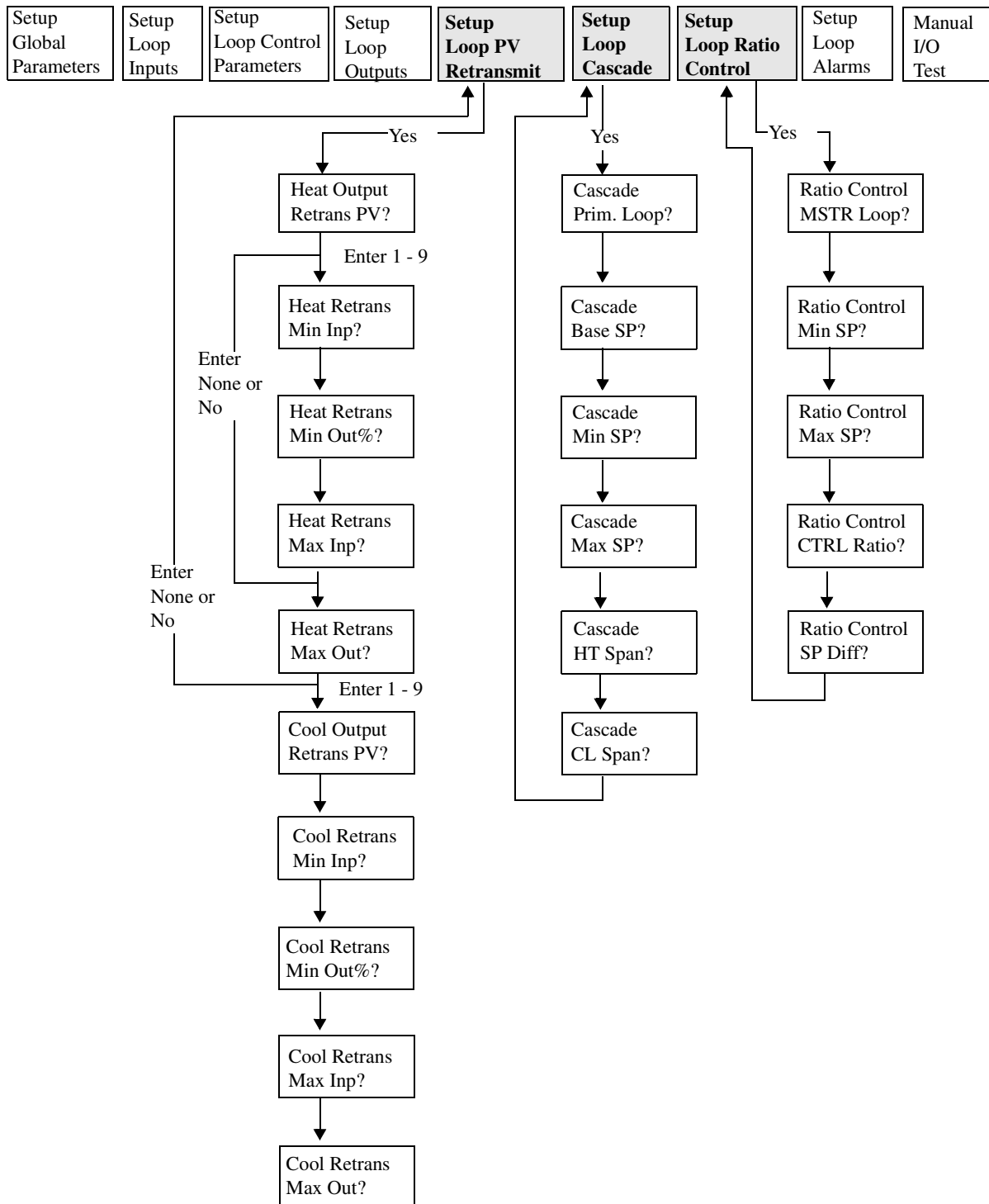

---

## Process Variable Retransmit

The PV Retransmit feature allows you to select the PV of any loop in the controller to be directed to any heat or cool output, including the loop which is providing the PV to be retransmitted. Once an output is defined as a “PV Retransmit”, it cannot be used for PID control.

### Setting Up a PV Retransmit

In order to set up a PV Retransmit, you must configure the following variables:

- 1) PV assignment: the number of the loop that provides the PV for the retransmit calculation.
- 2) Minimum input: the lowest value of the PV input. If the PV falls below the minimum, the output will stay at the minimum value. This value is expressed in the same engineering units as the input loop.
- 3) Minimum output: the output value (0-100%) which corresponds to the minimum input.
- 4) Maximum input: the highest value of the PV input. If the PV goes above the maximum, the output will stay at the maximum value. This value is expressed in the same engineering units as the input loop.
- 5) Maximum output: the output value (0-100%) which corresponds to the maximum input.

By adjusting the Maximum and Minimum inputs, you can scale the output appropriately:

**Linear Scaling of PV for Retransmit**

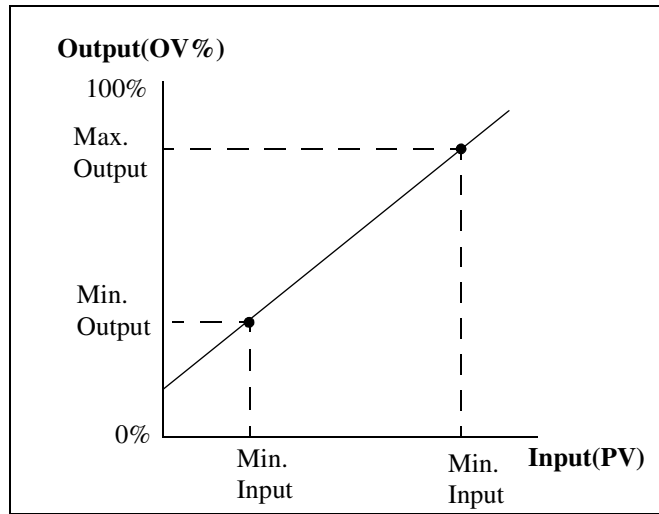

### PV Retransmit Menus

The Setup menus for the PV Retransmit feature appear under the Setup Loop PV Retransmit menu.

In order to view the PV retransmit menus, you need to select "Yes" at the following prompt.

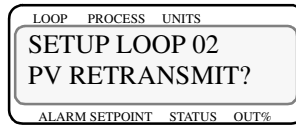

If you select "No" to the above screen, the controller skips down to the retransmit for cool. Cool is set up the same way that the heat is set up.

### PV Assignment



**Selectable Values:** Any loop or None (in this case, loop No. 02).

*Minimum Input*

LOOP	PROCESS	UNITS
02	HEAT RETRANS	
MIN INP? 1000		
ALARM SETPOINT	STATUS	OUT%

**Selectable Values:** From the input loop PV minimum reading to the maximum reading.

*Minimum Output*

LOOP	PROCESS	UNITS
02	HEAT RETRANS	
MIN OUT%? 0%		
ALARM SETPOINT	STATUS	OUT%



---

**NOTE**

**If you select a Min. Out other than 0%, one output will never drop below Min. Out, even if the PV drops below the Min. Input you specify.**

---

**Selectable Values:** 0-100%

*Maximum Input*

LOOP	PROCESS	UNITS
02	HEAT RETRANS	
MAX INP? 10000		
ALARM SETPOINT	STATUS	OUT%

**Selectable Values:** From the input loop PV minimum reading to the maximum reading.

### Maximum Output

LOOP	PROCESS	UNITS
02	HEAT RETRANS	
	MAX OUT%?	100%
ALARM SETPOINT	STATUS	OUT%

Output will never go above the this Maximum Output percentage, regardless of how high the PV goes.

**Selectable Values:** 0-100%.



---

#### NOTE

**Any available output (heat or cool) may be used as a retransmit output. Any PV (including the same loop number input) may be retransmitted.**

---

---

## Cascade Control

The Cascade control feature allows the output percentage of one control loop to influence the setpoint of a second control loop.

A loop designated as a Cascade output loop (primary loop) can still be used for direct PID control of an output. A single loop can be either set up as Cascade or Ratio control, but not both. The Cascade output loop is assigned to another control loop (secondary loop), which performs the actual control of the final control element.

### Setting Up Cascade Control

In order to set up Cascade control, you need to configure these variables:

- 1) Cascade output assignment. The control output (primary loop number) which will provide the output to the internal controller SP calculation for the secondary loop.
- 2) Base SP. The SP corresponding to 0% output (heat and cool) from the primary loop. This value is expressed in the same engineering units as the secondary loop PV, adjustable from the minimum reading to the maximum reading.
- 3) Minimum SP. The lowest value of the secondary loop SP. The minimum SP overrides any calculation caused by the primary loop calling for a lower SP. This value is expressed in the same engineering units as the secondary loop PV, adjustable from the minimum reading to the maximum reading.
- 4) Maximum SP. The highest value of the secondary loop SP. The maximum SP overrides any calculation caused by the primary loop calling for a higher SP. This value is expressed in the same engineering units as the secondary loop PV, adjustable from the minimum reading to the maximum reading.
- 5) Heat cascade span. The multiplier which is applied to the primary loop heat output percentage. The default value = Maximum SP - Base SP). The range is -9999 to +9999.
- 6) Cool cascade span. the multiplier which is applied to the primary loop cool output percentage. The default value = Minimum SP - Base SP). The range is -9999 to +9999.

- 7) By adjusting the SP parameters, the user can adjust the influence the primary loop has on the SP of the secondary loop.

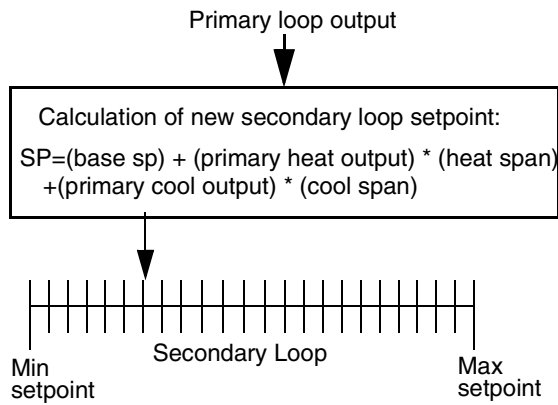

## Cascade Control Menus

The Setup menus for the Cascade control feature appear under the Setup Loop Cascade main menu (See *Setup* section in this manual).

In order to view the Cascade control menus, you need to choose "Yes" on the following menu.

LOOP	PROCESS	UNITS
SETUP LOOP 02		
CASCADE?		
ALARM SETPOINT	STATUS	OUT%

Answering YES to this prompt will allow you to set up the Cascade parameters with the loop currently displayed which performs the actual control of the final control element.

### *Cascade Output Assignment*

LOOP	PROCESS	UNITS
02 CASCADE		
PRIM. LOOP? 03		
ALARM SETPOINT	STATUS	OUT%

**Selectable Values:** Any loop except the secondary loop (in this case, loop No. 02).

### Base Setpoint

LOOP	PROCESS	UNITS
02 CASCADE		
BASE SP? 25		
ALARM SETPOINT	STATUS	OUT%

**Selectable Values:** From the secondary loop PV minimum reading to the maximum reading.

### Minimum Setpoint

LOOP	PROCESS	UNITS
02 CASCADE		
MIN SP? 25		
ALARM SETPOINT	STATUS	OUT%

**Selectable Values:** From the secondary loop PV minimum reading to the maximum reading.

### Maximum Setpoint

LOOP	PROCESS	UNITS
02 CASCADE		
MAX SP? 180		
ALARM SETPOINT	STATUS	OUT%

**Selectable Values:** From the secondary loop PV minimum reading to the maximum reading.

### Heat Cascade Span

LOOP	PROCESS	UNITS
02 CASCADE		
HT SPAN? ±9999		
ALARM SETPOINT	STATUS	OUT%

**Selectable Values:** Maximum setpoint to Base setpoint.

### Cool Cascade Span

LOOP	PROCESS	UNITS
02	CASCADE	
CL SPAN? $\pm$ 9999		
ALARM SETPOINT	STATUS	OUT%

**Selectable Values:** -9999 to 9999.



---

#### NOTE

**Cascade control cannot be used on the same control loop as Ratio control; however, both features may be used in the same multi-loop controller.**

---

## Ratio control

---

Ratio control allows you to specify a process variable of one loop, (Master loop), multiplied by a Ratio, to be the SP of another loop (Ratio loop). A single loop can be either set up as Cascade or Ratio control, but not both. You can assign any Process Variable to determine the SP of a Ratio loop.

### Setting Up Ratio Control

In order to set up Ratio control, you must configure the following variables:

- 1) Ratio Process Variable assignment. The Master loop PV which will provide the output to the internal controller SP calculation for the Ratio loop SP.
- 2) Minimum SP. The lowest allowable value of the Ratio loop SP. The minimum SP overrides any calculation caused by the Ratio calculation calling for a lower SP. This value is expressed in the same engineering units as the Ratio loop PV, adjustable from the minimum reading to the maximum reading.
- 3) Maximum SP. The highest allowable value of the Ratio loop SP. The maximum SP overrides any calculation caused by the Ratio calculation calling for a higher SP. This value is expressed in the same engineering units as the Ratio loop PV, adjustable from the minimum reading to the maximum reading.
- 4) Control Ratio. The multiplier which is applied to the Master loop PV.
- 5) SP Differential. The amount to be added or subtracted from the Ratio loop SP calculation before it is used as a SP. This value is expressed in the same engineering units as the Ratio loop PV, adjustable from the minimum reading to the maximum reading.

By adjusting the Ratio control parameters, you can adjust the influence the Master loop PV has on the SP of the Ratio loop.

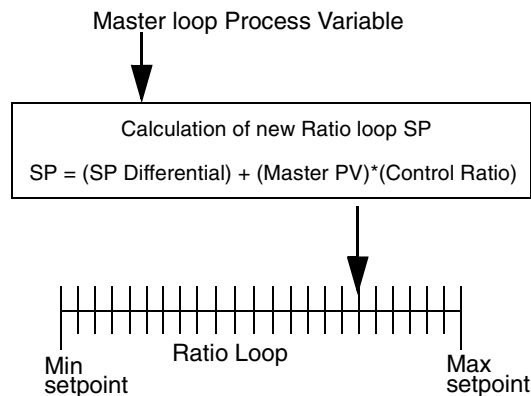

## Ratio Control Menus

The Ratio control parameters appear under a new menu option, which follows the Cascade menu:

LOOP	PROCESS	UNITS
SETUP LOOP 02 RATIO CONTROL?		
ALARM SETPOINT	STATUS	OUT%

Answering YES to this prompt will allow you to set up the Ratio control parameters with loop number 02 as the Ratio loop, which performs the actual control of the final control element.

### *Ratio PV Assignment*

LOOP	PROCESS	UNITS
02 RATIO CONTROL MSTR LOOP? NONE		
ALARM SETPOINT	STATUS	OUT%

**Selectable Values:** You may select from all the loops in the controller except the loop currently selected (in this example loop 02). Choose NONE for no Ratio control.

### *Minimum Setpoint*

LOOP	PROCESS	UNITS
02 RATIO CONTROL MIN SP? 25		
ALARM SETPOINT	STATUS	OUT%

**Selectable Values:** From the ratio loop PV minimum reading to the maximum reading.

### *Maximum Setpoint*

LOOP	PROCESS	UNITS
02 RATIO CONTROL MAX SP? 25		
ALARM SETPOINT	STATUS	OUT%

**Selectable Values:** From the ratio loop PV minimum reading to the maximum reading.

### *Control Ratio*

LOOP	PROCESS	UNITS
02 RATIO CONTROL CTRL RATIO? 1.0		
ALARM SETPOINT	STATUS	OUT%

**Selectable Values:** 0.1 to 999.9.

### Setpoint Differential

LOOP	PROCESS	UNITS
02 RATIO CONTROL		
SP DIFF.? 0		
ALARM	SETPOINT	STATUS
		OUT%

**Selectable Values:** From the ratio loop PV minimum reading to the maximum reading.



---

#### NOTE

**Ratio control cannot be used on the same control loop as Cascade control; however, both features may be used in the same multi-loop controller.**

---



---

## Remote Analog setpoint

The Remote Analog Setpoint (Remote SP) is set up identically to the Ratio control. If you wish to use a Remote SP, an analog input from one of the control loops is typically connected to an external current or voltage source, which can be defined as Linear. All other input types are also usable as Remote SP inputs.

The loop which contains the Remote SP input is the “Master loop“, and the Ratio control parameters are set up as outlined in the *Ratio control* section of this appendix.

---

## Differential Control

Differential control is a function you enable through the Ratio control feature, which allows a process to be controlled at a difference to another process. You enable the Differential control by setting the Ratio value to 1.0 and adjusting the differential to accommodate the desired offset.

## Typical Applications

This section provides usage examples of the Enhanced features for the CLS and MLS manuals.

### Process Variable Retransmit

The Process Variable Retransmit [PVR] feature provides retransmission of the process signal of one channel [primary] via the control output of another channel [secondary]. This signal is a linear output signal which is proportional to the engineering units of the primary channel input.

The controller output signal must be connected to a DAC converter in order to get an analog signal of 4-20 MAdc or 0-5 Vdc. The type of DAC ordered depends on application requirements.

Some typical uses would be for data logging to older style analog recording systems, or long distance transmission of the primary signal to avoid degradation of the primary signal. The signal can also be used as an input to other types of control systems such as a PLC.

An 8CLS controls the temperature of a furnace. The thermocouple in one of the zones is connected to the CLS and is used for closed-loop PID control. An analog recorder data logging system is also in place, and a recording of the process temperature is required. The recorder input is a linear 4-20mAdc signal representing a range of 0-1000°F.

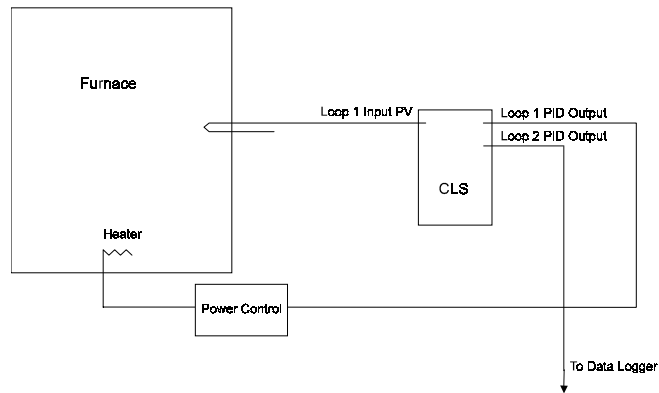

- 1) First, set up the standard control loop parameters according to the furnace application, in this case on loop 1.
- 2) Select another unused PID output for retransmitting the thermocouple value (for example, loop 2 heat output).
- 3) Change the display to loop 2, and then enter the 3-key sequence to display the following:

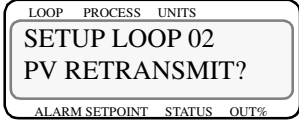
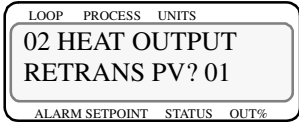
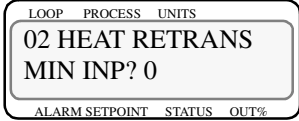
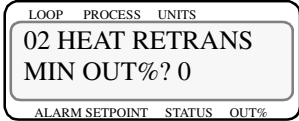
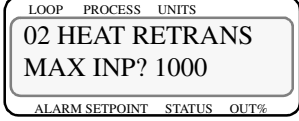
Display	User Input
	Press <b>Yes</b> .
	Enter 01 for loop 01 PV. Press <b>Enter</b> .
	Enter the minimum input value, which will correspond to the minimum output percentage. For a range of 0-1000 °F, the minimum input value is 0 °F. Change the MIN INP to 0. Press <b>Enter</b> .
	Enter the minimum output percentage, from 0 to 100%. For this example we will assume a full span with a minimum of 0%. Press <b>Enter</b> .
	Enter the maximum input value, which corresponds to the maximum output percentage. For a range of 0-1000 °F, the maximum input value is 1000 °F. Change the MAX INP to 1000. Press <b>Enter</b> .

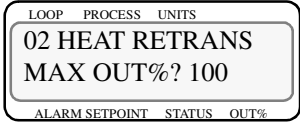
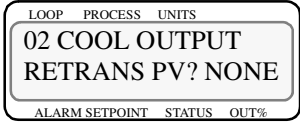
Display	User Input
 <p>LOOP PROCESS UNITS 02 HEAT RETRANS MAX OUT%? 100 ALARM SETPOINT STATUS OUT%</p>	<p>Enter the maximum output percentage, from 0 to 100%. For this example we will assume a full span with a maximum of 100%. Press <b>Enter</b>.</p>
 <p>LOOP PROCESS UNITS 02 COOL OUTPUT RETRANS PV? NONE ALARM SETPOINT STATUS OUT%</p>	<p>The PV retransmit section of the CLS programming is now completed. You are not using the cool output of loop 2 for retransmitting a PV, so choose None. Press <b>Enter</b>.</p>

Now press the "Back" key several times until the normal loop display appears. The Process Variable Retransmit will now produce an output on Channel 2 Output which is linear and proportional to Channel 1 Process Variable.

This is not a T/C curve type of signal and requires a linear input range in the recorder.

To complete this configuration, the Channel 2 Output must be enabled and tailored to meet the requirements of the data-application. In this example using a data logging recorder, the data-logger will most likely require an analog output 4-20 mA, or 0-1 Vdc, or 1-5 Vdc, or 0-5 Vdc.

The CLS/MLS line of controllers must be used with an Watlow Anafaze Dual Dac [Digital to Analog Converter] or SDAC (Serial Digital to Analog Converter) for proper signal conversion.

The Dual Dac accuracy on retransmit is .75% of reading which matches the standard T/C rated accuracy statement of .75% of reading.

For higher accuracies of .05% of full scale, the SDAC is recommended.

Please consult the SETUP Section of this manual for information on setting up the other options of the controller.

## Cascade Control

Cascade Control is used to control thermal systems with long lag times, which cannot be as accurately controlled with a single control loop. The output of the first (primary) loop is used to adjust the setpoint of the second (secondary) loop. The secondary loop normally executes the actual PID control.

In some applications, there are two zone cascade control systems where the primary channel PID output is used for the primary heat control and the secondary cascaded channel PID output is used for a heat boost in a second zone. These are used in the metals market such as aluminum casting industries. You can use the primary heat output for both control and for determining the setpoint of the secondary loop.

A customer has a tank of water, which has an inner and outer thermocouple. The inner thermocouple is located in the center of the water. The outer thermocouple is located near the heating element. The desired temperature of the water is 150°F, which is measured at the inner thermocouple. Using cascade, the inner thermocouple is used on the primary loop (in this example, PID loop 1), and the outer thermocouple is used on the secondary loop (PID loop 2). The heater will be controlled by loop 2 with a SP range of 150-190 °F..

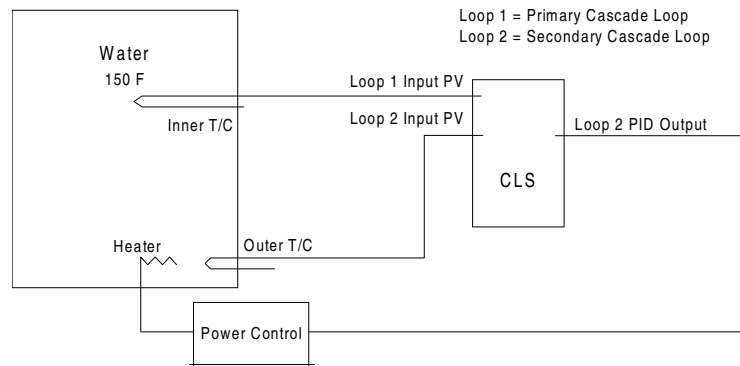

Using the 4CLS Watlow Anafaze controller equipped with the Enhanced Control Option firmware, the programming sequence is described below.

First, switch the controller to display loop 2, which will be the secondary loop, and then enter the 3-key sequence to display the following:

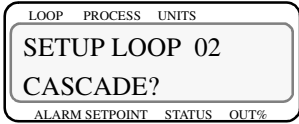
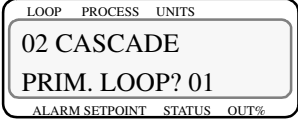
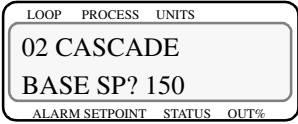
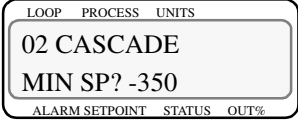
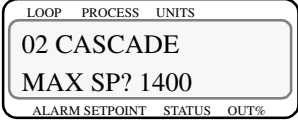
Display	User Input
	<p>Press <b>Yes</b> to setup the Cascade parameters with loop 2 as the secondary loop.</p>
	<p>Enter 01 to make loop 1 the primary loop. Press <b>Enter</b>.</p>
	<p>The base setpoint corresponds to the 0% level output of the primary channel. Enter the base SP of the secondary loop. For this example we will assume a base SP of 150°F, which is the desired water temperature. Press <b>Enter</b>.</p>
	<p>Enter the minimum SP of the secondary loop. For this example we will use a minimum SP of -350°F. Normal cascade applications will not require this to be changed. Press <b>Enter</b>.</p>
	<p>Enter the maximum SP of the secondary loop. For this example we will use a maximum SP of 1400°F. Normal cascade applications will not require this to be changed. Press <b>Enter</b>.</p>

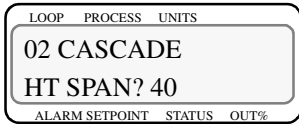
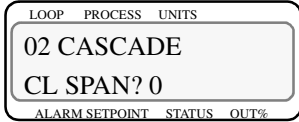
Display	User Input
 <p>The screenshot shows a control display with a header 'LOOP PROCESS UNITS' and a footer 'ALARM SETPOINT STATUS OUT%'. The main display area shows '02 CASCADE' and 'HT SPAN? 40'.</p>	<p>Enter the heat span of the secondary loop. This is the span over which the primary output from 0-100% is used to change the setpoint. For this example we will assume a linear rise in SP, so the heat span is 40°F. Press <b>Enter</b>.</p>
 <p>The screenshot shows a control display with a header 'LOOP PROCESS UNITS' and a footer 'ALARM SETPOINT STATUS OUT%'. The main display area shows '02 CASCADE' and 'CL SPAN? 0'.</p>	<p>Enter the cool span of the secondary loop. For this example we will assume no low-side adjustment to the SP, so the cool span is 0°F. Press <b>Enter</b>.</p>

Now press the "Back" key several times until the normal loop display appears. The output percentage of loop 1 will now control the setpoint of loop 2. You may set Channel 1 to Manual and the Output to 0%, Channel 2 SP should =150. Adjust Channel 1 Manual Output to 50%, Channel 2 SP should =170. Adjust Channel 1 Manual Output to 100%, Channel 2 SP should =190.

To complete the cascade setup, both loop 1 and loop 2 must be configured for inputs, outputs, and alarms.

In addition, the PID parameters of loop 1 must be tuned to produce the desired effect for the application on the setpoint of loop 2. For a cascade control application that uses the secondary loop for PID control, then Loop 1 must use only proportional mode. This must be set for the amount of change in the PV to cause a 100% change in the output level.

It is necessary for the temperature of Loop 1 temperature to drop only 10 °F in order for Loop 2 to change from 150 to 190 °F. Then set the PB of loops 1 to 10, and turn off Intergal and Derivative terms by setting TI and TD to 0.

The PID parameters of loop 2 must be tuned to perform efficient control.

For two-zone cascade control systems, the PID settings for both loops, the primary plus the secondary, must be optimized for good temperature control.

Please consult the SETUP Section of this manual for information on tuning PID loops.

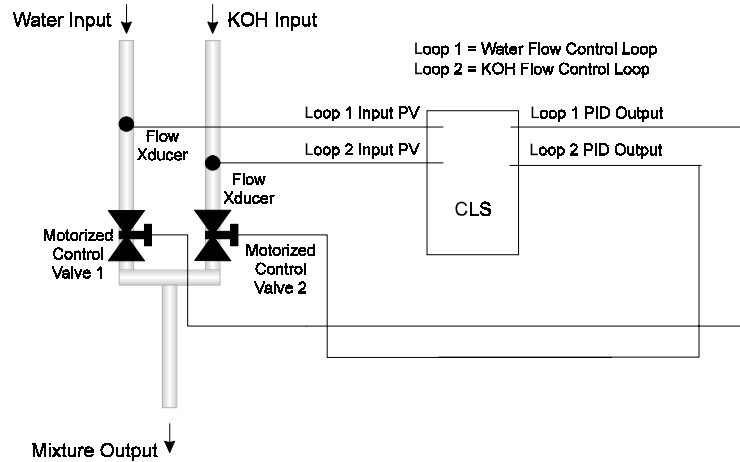

## Ratio Control

A chemical process requires a formula of two parts Water (H<sub>2</sub>O) to one part Potassium Hydroxide (KOH) to produce diluted Potassium Hydroxide. The desired flow of H<sub>2</sub>O is 10 gallons per second (gps), and the KOH should be 5 gps. Each chemical has a pipe feeding a common pipe. The flow rate of each feeder pipe is measured and supplied to a 4CLS, with H<sub>2</sub>O flow as PV1 and KOH flow as PV2. The outputs of loops 1 and 2 adjust motorized valves.

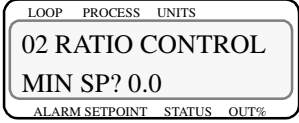
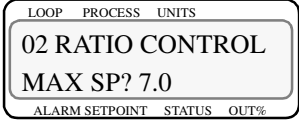

- 1) Adjust and tune Loop 1 (H<sub>2</sub>O) for optimal performance before implementing the Ratio setup.
- 2) Switch the controller to display loop 2 (KOH), and then enter the 3-key sequence to display the following:

Display	User Input
<div style="border: 1px solid black; padding: 5px; width: fit-content; margin: auto;"> <small>LOOP   PROCESS   UNITS</small>  <b>SETUP LOOP 02</b>  <b>RATIO CONTROL?</b>  <small>ALARM SETPOINT   STATUS   OUT%</small> </div>	Press <b>Yes</b> to setup the Ratio parameters for loop 02.
<div style="border: 1px solid black; padding: 5px; width: fit-content; margin: auto;"> <small>LOOP   PROCESS   UNITS</small>  <b>02 RATIO CONTROL</b>  <b>MSTR LOOP? 01</b>  <small>ALARM SETPOINT   STATUS   OUT%</small> </div>	Assign loop 01 to be the master loop. Press <b>Enter</b> .

Display	User Input
 <p>02 RATIO CONTROL MIN SP? 0.0</p>	<p>Enter the minimum Ratio loop SP. For this example, we will use 0 gallons per minute as a minimum</p> <p>Press <b>Enter</b>.</p>
 <p>02 RATIO CONTROL MAX SP? 7.0</p>	<p>Enter the maximum Ratio loop SP. For this example, we will use 7.0 gallons per minute as a maximum</p> <p>Press <b>Enter</b>.</p>
 <p>02 RATIO CONTROL CTRL: RATIO? 0.5</p>	<p>Enter the control ratio, which is the multiple applied to the master Process Variable (the H<sub>2</sub>O flow rate is multiplied by 0.5 to obtain the KOH flow rate setpoint).</p> <p>Press <b>Enter</b>.</p>
 <p>02 RATIO CONTROL SP DIFF.? 0</p>	<p>Enter the setpoint differential (or offset). For this example we have no offset requirement and will use 0</p> <p>Press <b>Enter</b>.</p>

Now press **Back** several times until the normal loop display appears.

The setpoint of loop 2 will now be equal to one half of the process variable of loop 2. To complete the ratio setup, configure both loops 1 and 2 for inputs, outputs, and alarms. Please consult the *Setup* section of the manual for information on PID loop setup.

## Remote Setpoint



Remote Setpoint can be used to allow external equipment, such as a PLC or other control system, to provide an analog output (4-20 mA, 0-5 Vdc, etc.) used to change the setpoint of a loop. The method of configuring the Remote Setpoint is the same as Ratio Control. In the previous example, loop 1 would be the remote analog value and loop 2 would be the PID control loop.



Both the remote setpoint feature and the PV retransmit feature can be used with PLC systems as the link between multi-loop PID control systems and PLC systems.

For example, a 0-5 Vdc signal representing 0-300 °F will be used as a remote SP input to the CLS. The input signal will be received on Loop 1 with the control being performed on Loop 2. Note that proper scaling resistors must be installed on the input of Loop 1 to allow it to accept a 0-5Vdc input.

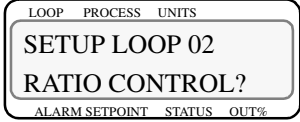
From the loop 1 input channel, select the Linear Input Type. Set HiPV = 300, LoPV = 0, HiRDG = 100.0%, and LoRDG = 0.0%.

Next go to loop 2 and enter the programming menus. Go to the Ratio Option Menu and press the YES key to select the Ratio Menu.

Display	User Input
	<p>Press <b>Yes</b> to setup the Ratio parameters for loop 02.</p>
	<p>Assign loop 01 to be the master loop. Press <b>Enter</b>.</p>
	<p>Enter the minimum Ratio loop SP. For this example, we will use 0 °F. Press <b>Enter</b>.</p>

Display	User Input
 <p>02 RATIO CONTROL MAX SP? 300</p>	<p>Enter the maximum Ratio loop SP. For this example, we will use 300 °F as a maximum</p> <p>Press <b>Enter</b>.</p>
 <p>02 RATIO CONTROL CTRL: RATIO? 1.0</p>	<p>Enter the control ratio, which is the multiple applied to the master Process Variable. In this example the ration is 1.0.</p> <p>Press <b>Enter</b>.</p>
 <p>02 RATIO CONTROL SP DIFF.? 0</p>	<p>Enter the setpoint differential (or offset). For this example we have no offset requirement and will use 0</p> <p>Press <b>Enter</b>.</p>

Now press the "Back" key several times until the normal loop display appears. The setpoint of loop 2 will now be equal to the Input range of Loop 1, which is 0-5 Vdc which is representative of the 0-300 °F.

To complete the Remote SP setup, Loop 1 may be configured for outputs and alarms. Likewise, Loop 2 must be configured for inputs, outputs, and alarms.

Please consult the SETUP Section of this manual for information on PID loop setup.

## Differential Control

Differential Control is a simple application of the Ratio Control option, used to control one process at a differential (or offset) to another.



A thermal forming application requires that the outside heaters operate at a higher temperature than the center heaters. In some applications these may be in bands of temperatures. The diferential control point is determined by the Master channel which is using IR sensors for temperture feedback. Secondary loops will be using T/Cs for feedback.



The loops using the IR sensor as an input is assigned to the Master Loop in the Ratio Control Option Menu. The secondary loop is the Differential control loop. By setting the setpoint differential "SP DIFF." to the desired offset, this will produce the desired offset between the secondary and master loop setpoints for differential control.

For example setpoints, the Master Loop can be controlled at 325 °F and the secondary loop at 375 °F by using a differential of 50 °F.

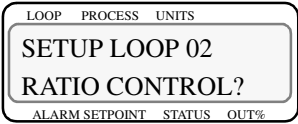
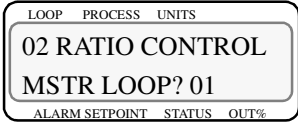
Channel 1 must be set up for PID control of the SP at 325 °F.

Go to Channel 2 and enter the programming menus. Go to the Ratio Option Menu and press the YES Key to select the Ratio Menu.

Display	User Input
	<p>Press <b>Yes</b> to setup the Ratio parameters for loop 02.</p>
	<p>Assign loop 01 to be the master loop. Press <b>Enter</b>.</p>
	<p>Enter the maximum Ratio loop SP. For this example, we will use 400 °F as a maximum Press <b>Enter</b>.</p>
	<p>Enter the minimum Ratio loop SP. For this example, we will use 300 °F. Press <b>Enter</b>.</p>

Display	User Input
 <p>The screenshot shows a control panel for '02 RATIO CONTROL'. At the top, it lists 'LOOP PROCESS UNITS'. The main display area shows 'CTRL: RATIO? 1.0'. At the bottom, it lists 'ALARM SETPOINT STATUS OUT%'.</p>	<p>Enter the control ratio, which is the multiple applied to the master Process Variable. In this example the ration is 1.0. Press <b>Enter</b>.</p>
 <p>The screenshot shows the same control panel for '02 RATIO CONTROL'. The main display area now shows 'SP DIFF.? 50'. The other elements remain the same.</p>	<p>Enter the setpoint differential (or offset). For this example we have an offset of +50. Press <b>Enter</b>.</p>

Now press the "Back" key several times until the normal loop display appears. The setpoint of loop 2 will now be equal to SP of Loop 1 plus 50 °F.

To complete the Differential Control setup, Loop 1 and Loop 2 must be configured for inputs, outputs, and alarms. Please consult The SETUP Section of the manual for information on PID loop setup.



# Glossary

## A

### AC

See Alternating Current.

### AC Line Frequency

The frequency of the AC power line measured in Hertz (Hz), usually 50 or 60 Hz.

### Accuracy

Closeness between the value indicated by a measuring instrument and a physical constant or known standards.

### Action

The response of an output when the process variable is changed. See also Direct action, Reverse action.

### Address

A numerical identifier for a controller when used in computer communications.

### Alarm

A signal that indicates that the process has exceeded or fallen below a certain range around the setpoint. For example, an alarm may indicate that a process is too hot or too cold. See also:

- Deviation Alarm
- Failed Sensor Alarm
- Global Alarm
- High Deviation Alarm
- High Process Alarm
- Loop Alarm
- Low Deviation Alarm
- Low Process Alarm

### Alarm Delay

The lag time before an alarm is activated.

### Alternating Current (AC)

An electric current that reverses at regular intervals, and alternates positive and negative values.

### Ambient Temperature

The temperature of the air or other medium that surrounds the components of a thermal system.

### American Wire Gauge (AWG)

A standard of the dimensional characteristics of wire used to conduct electrical current or signals. AWG is identical to the Brown and Sharpe (B&S) wire gauge.

### Ammeter

An instrument that measures the magnitude of an electric current.

### Ampere (Amp)

A unit that defines the rate of flow of electricity (current) in the circuit. Units are one coulomb ( $6.25 \times 10^{18}$  electrons) per second.

### Analog Output

A continuously variable signal that is used to represent a value, such as the process value or setpoint value. Typical hardware configurations are 0-20mA, 4-20mA or 0-5 Vdc.

### Automatic Mode

A feature that allows the controller to set PID control outputs in response to the Process Variable (PV) and the setpoint.

### Autotune

A feature that automatically sets temperature control PID values to match a particular thermal system.

## B

### Bandwidth

A symmetrical region above and below the setpoint in which proportional control occurs.

### Baud Rate

The rate of information transfer in serial communications, measured in bits per second.

**Block Check Character (BCC)**

A serial communications error checking method. An acceptable method for most applications, BCC is the default method. See CRC.

**Bumpless Transfer**

A smooth transition from Auto (closed loop) to Manual (open loop) operation. The control output does not change during the transfer.

**C**

**Calibration**

The comparison of a measuring device (an unknown) against an equal or better standard.

**Celsius (Centigrade)**

Formerly known as Centigrade. A temperature scale in which water freezes at 0°C and boils at 100°C at standard atmospheric pressure. The formula for conversion to the Fahrenheit scale is: °F=(1.8x°C)+32.

**Central Processing Unit (CPU)**

The unit of a computing system that includes the circuits controlling the interpretation of instructions and their execution.

**Circuit**

Any closed path for electrical current. A configuration of electrically or electromagnetically-connected components or devices.

**Closed Loop**

A control system that uses a sensor to measure a process variable and makes decisions based on that feedback.

**Cold Junction**

Connection point between thermocouple metals and the electronic instrument.

**Common Mode Rejection Ratio**

The ability of an instrument to reject electrical noise, with relation to ground, from a common voltage. Usually expressed in decibels (dB).

**Communications**

The use of digital computer messages to link components.  
See Serial Communications.  
See Baud Rate.

**Control Action**

The response of the PID control output relative to the error between the process variable and the setpoint. For reverse action (usually heating), as the process decreases below the setpoint the output increases. For direct action (usually cooling), as the process increases above the setpoint, the output increases.

**Control Mode**

The type of action that a controller uses. For example, On/Off, time proportioning, PID, Automatic or manual, and combinations of these.

**Current**

The rate of flow of electricity. The unit of measure is the ampere (A).  
1 ampere = 1 coulomb per second.

**Cycle Time**

The time required for a controller to complete one on-off-on cycle. It is usually expressed in seconds.

**Cyclic Redundancy Check (CRC)**

An error checking method in communications. It provides a high level of data security but is more difficult to implement than Block Check Character (BCC).  
See Block Check Character.

**D**

**Data Logging**

A method of recording a process variable over a period of time. Used to review process performance.

**Deadband**

The range through which a variation of the input produces no noticeable change in the output. In the deadband, specific conditions can be placed on control output actions. Operators select the deadband. It is usually above the heating proportional band and below the cooling proportional band.

**Default Parameters**

The programmed instructions that are permanently stored in the microprocessor software.

**Derivative Control (D)**

The last term in the PID algorithm. Action that anticipated the rate of change of the process, and compensates to minimize overshoot and undershoot. Derivative control is an instantaneous change of the control output in the same direction as the proportional error. This is caused by a change in the process variable (PV) that decreases over the time of the derivative (TD). The TD is in units of seconds.

**Deutsche Industrial Norms (DIN)**

A set of technical, scientific and dimensional standards developed in Germany. Many DIN standards have worldwide recognition.

**Deviation Alarm**

Warns that a process has exceeded or fallen below a certain range around the setpoint.

**Digital to Analog Converter (DAC)**

A device that converts a numerical input signal to a signal that is proportional to the input in some way.

**Direct Action**

An output control action in which an increase in the process variable, causes an increase in the output. Cooling applications usually use direct action.

**Direct Current (DC)**

An electric current that flows in one direction.

**Distributed Zero Crossing (DZC)**

A form of digital output control. Similar to burst fire.

**E****Earth Ground**

A metal rod, usually copper, that provides an electrical path to the earth, to prevent or reduce the risk of electrical shock.

**Electrical Noise**

See Noise.

**Electromagnetic Interference (EMI)**

Electrical and magnetic noise imposed on a system. There are many possible causes, such as switching ac power on inside the sine wave. EMI can interfere with the operation of controls and other devices.

**Electrical-Mechanical Relays**

See Relay, electromechanical.

**Emissivity**

The ratio of radiation emitted from a surface compared to radiation emitted from a blackbody at the same temperature.

**Engineering Units**

Selectable units of measure, such as degrees Celsius and Fahrenheit, pounds per square inch, newtons per meter, gallons per minute, liters per minute, cubic feet per minute or cubic meters per minute.

**EPROM**

Erasable Programmable, Read-Only Memory inside the controller.

**Error**

The difference between the correct or desired value and the actual value.

**F****Fahrenheit**

The temperature scale that sets the freezing point of water at 32°F and its boiling point at 212°F at standard atmospheric pressure. The formula for conversion to Celsius is:  $^{\circ}\text{C} = 5/9 (^{\circ}\text{F} - 32^{\circ}\text{F})$ .

**Failed Sensor Alarm**

Warns that an input sensor no longer produces a valid signal. For example, when there are thermocouple breaks, infrared problems or resistance

temperature detector (RTD) open or short failures.

### **Filter**

Filters are used to handle various electrical noise problems.

**Digital Filter (DF)** — A filter that allows the response of a system when inputs change unrealistically or too fast. Equivalent to a standard resistor-capacitor (RC) filter

**Digital Adaptive Filter** — A filter that rejects high frequency input signal noise (noise spikes).

**Heat/Cool Output Filter** — A filter that slows the change in the response of the heat or cool output. The output responds to a step change by going to approximately 2/3 its final value within the numbers of scans that are set.

### **Frequency**

The number of cycles over a specified period of time, usually measured in cycles per second. Also referred to as Hertz (Hz). The reciprocal is called the period.

## **G**

### **Gain**

The amount of amplification used in an electrical circuit. Gain can also refer to the Proportional (P) mode of PID.

### **Global Alarm**

Alarm associated with a global digital output that is cleared directly from a controller or through a user interface.

### **Global Digital Outputs**

A pre-selected digital output for each specific alarm that alerts the operator to shut down critical processes when an alarm condition occurs.

### **Ground**

An electrical line with the same electrical potential as the surrounding earth. Electrical systems are usually grounded to protect people and equipment from shocks due to malfunctions. Also referred to a "safety ground".

## **H**

### **Hertz(Hz)**

Frequency, measured in cycles per second.

### **High Deviation Alarm**

Warns that the process is above setpoint, but below the high process variable. It can be used as either an alarm or control function.

### **High Power**

Any voltage above 24 VAC or Vdc and any current level above 50 mAac or mAdc.

### **High Process Alarm**

A signal that is tied to a set maximum value that can be used as either an alarm or control function.

### **High Process Variable (PV)**

See Process Variable (PV).

### **High Reading**

An input level that corresponds to the high process value. For linear inputs, the high reading is a percentage of the full scale input range. For pulse inputs, the high reading is expressed in cycles per second (Hz).

## **I**

### **Infrared**

A region of the electromagnetic spectrum with wavelengths ranging from one to 1,000 microns. These wavelengths are most suited for radiant heating and infrared (noncontact) temperature sensing.

### **Input**

Process variable information that is supplied to the instrument.

### **Input Scaling**

The ability to scale input readings (readings in percent of full scale) to the engineering units of the process variable.

**Input Type**

The signal type that is connected to an input, such as thermocouple, RTD, linear or process.

**Integral Control (I)**

Control action that automatically eliminates offset, or droop, between setpoint and actual process temperature.

See Auto-reset.

**J****Job**

A set of operating conditions for a process that can be stored and recalled in a controller's memory. also called a Recipe.

**Junction**

The point where two dissimilar metal conductors join to form a thermocouple.

**L****Lag**

The delay between the output of a signal and the response of the instrument to which the signal is sent.

**Linear Input**

A process input that represents a straight line function.

**Linearity**

The deviation in response from an expected or theoretical straight line value for instruments and transducers. also called Linearity Error.

**Liquid Crystal Display (LCD)**

A type of digital display made of a material that changes reflectance or transmittance when an electrical field is applied to it.

**Load**

The electrical demand of a process, expressed in power (watts), current (amps), or resistance (ohms). The item or substance that is to be heated or cooled.

**Loop Alarm**

Any alarm system that includes high and low process, deviation band, deadband, digital outputs, and auxiliary control outputs.

**Low Deviation Alarm**

Warns that the process is below the setpoint, but above the low process variable. It can be used as either an alarm or control function.

**Low Process Alarm**

A signal that is tied to a set minimum value that can be used as either an alarm or control function.

**Low Reading**

An input level corresponding to the low process value. For linear inputs, the low reading is a percentage of the full scale input range. For pulse inputs, the low reading is expressed in cycles per second (Hz).

**M****Manual Mode**

A selectable mode that has no automatic control aspects. The operator sets output levels.

**Manual Reset**

See Reset.

**Milliampere (mA)**

One thousandth of an ampere.

**N****No Key Reset**

A method for resetting the controller's memory (for instance, after an EPROM change).

**Noise**

Unwanted electrical signals that usually produce signal interference in sensors and sensor circuits. See Electromagnetic Interference.

**Noise Suppression**

The use of components to reduce electrical interference that is caused by making or breaking electrical contact, or by inductors.

### **Non Linear**

Through Watlow-Anafaze software, the Non Linear field sets the system to linear control, or to one of two non linear control options. Input 0 for Linear, 1 or 2 for non linear.

## **O**

### **Offset**

The difference in temperature between the setpoint and the actual process temperature. Offset is the error in the process variable that is typical of proportional-only control.

### **On/Off Control**

A method of control that turns the output full on until setpoint is reached, and then off until the process error exceeds the hysteresis.

### **Open Loop**

A control system with no sensory feedback.

### **Operator Menus**

The menus accessible from the front panel of a controller. These menus allow operators to set or change various control actions or features.

### **Optical Isolation**

Two electronic networks that are connected through an LED (Light Emitting Diode) and a photoelectric receiver. There is no electrical continuity between the two networks.

### **Output**

Control signal action in response to the difference between setpoint and process variable.

### **Output Type**

The form of PID control output, such as Time Proportioning, Distributed Zero Crossing, SDAC, or Analog. Also the description of the electrical hardware that makes up the output.

### **Overshoot**

The amount by which a process variable exceeds the setpoint before it stabilizes.

## **P**

### **Panel Lock**

A feature that prevents operation of the front panel by unauthorized people.

### **PID**

Proportional, Integral, Derivative. A control mode with three functions:

Proportional action dampens the system response, Integral corrects for droops, and Derivative prevents overshoot and undershoot.

### **Polarity**

The electrical quality of having two opposite poles, one positive and one negative. Polarity determines the direction in which a current tends to flow.

### **Process Variable**

The parameter that is controlled or measured. Typical examples are temperature, relative humidity, pressure, flow, fluid level, events, etc. The high process variable is the highest value of the process range, expressed in engineering units. The low process variable is the lowest value of the process range.

### **Proportional (P)**

Output effort proportional to the error from setpoint. For example, if the proportional band is 20° and the process is 10° below the setpoint, the heat proportioned effort is 50%. The lower the PB value, the higher the gain.

### **Proportional Band (PB)**

A range in which the proportioning function of the control is active. Expressed in units, degrees or percent of span.  
See PID.

### **Proportional Control**

A control using only the P (proportional) value of PID control.

### **Pulse Input**

Digital pulse signals from devices, such as optical encoders.

## R

### Ramp

A programmed increase in the temperature of a setpoint system.

### Range

The area between two limits in which a quantity or value is measured. It is usually described in terms of lower and upper limits.

### Recipe

See Job.

### Reflection Compensation Mode

A control feature that automatically corrects the reading from a sensor.

### Relay

A switching device.

**Electromechanical Relay** — A power switching device that completes or interrupts a circuit by physically moving electrical contacts into contact with each other. Not recommended for PID control.

**Solid State Relay (SSR)** — A switching device with no moving parts that completes or interrupts a circuit electrically.

### Reset

Control action that automatically eliminates offset or droop between setpoint and actual process temperature.

See also Integral.

**Automatic Reset** — The integral function of a PI or PID temperature controller that adjusts the process temperature to the setpoint after the system stabilizes. The inverse of integral.

**Automatic Power Reset** — A feature in latching limit controls that

### Resistance

Opposition to the flow of electric current, measured in ohms.

### Resistance Temperature Detector (RTD)

A sensor that uses the resistance temperature characteristic to measure temperature. There are two basic types of RTDs: the wire RTD, which is usually made of platinum, and the thermistor which is made of a semiconductor material. The wire RTD is a positive temperature coefficient sensor only, while the thermistor can have either a negative or positive temperature coefficient.

### Reverse Action

An output control action in which an increase in the process variable causes a decrease in the output. Heating applications usually use reverse action.

### RTD

See Resistance Temperature Detector.

## S

### Serial Communications

A method of transmitting information between devices by sending all bits serially over a single communication channel.

**RS-232**—An Electronics Industries of America (EIA) standard for interface between data terminal equipment and data communications equipment for serial binary data interchange. This is usually for communications over a short distance (50 feet or less) and to a single device.

**RS-485**—An Electronics Industries of America (EIA) standard for electrical characteristics of generators and receivers for use in balanced digital multipoint systems. This is usually used to communicate with multiple devices over a common cable or where distances over 50 feet are required.

### Setpoint (SP)

The desired value programmed into a controller. For example, the temperature at which a system is to be maintained.

### Shield

A metallic foil or braided wire layer surrounding conductors that is designed to prevent electrostatic or electromagnetic interference from external sources.

**Signal**

Any electrical transmittance that conveys information.

**Solid State Relay (SSR)**

See Relay, Solid State.

**Span**

The difference between the lower and upper limits of a range expressed in the same units as the range.

**Spread**

In heat/cool applications, the +/- difference between heat and cool. Also known as process deadband.

See deadband.

**Stability**

The ability of a device to maintain a constant output with the application of a constant input.

**T**

**T/C Extension Wire**

A grade of wire used between the measuring junction and the reference junction of a thermocouple. Extension wire and thermocouple wire have similar properties, but extension wire is less costly.

**TD (Timed Derivative)**

The derivative function.

**Thermistor**

A temperature-sensing device made of semiconductor material that exhibits a large change in resistance for a small change in temperature. Thermistors usually have negative temperature coefficients, although they are also available with positive temperature coefficients.

**Thermocouple (T/C)**

A temperature sensing device made by joining two dissimilar metals. This junction produces an electrical voltage in proportion to the difference in temperature between the hot junction (sensing junction) and the lead wire connection to the instrument (cold junction).

**TI (Timed Integral)**

The Integral term.

**Transmitter**

A device that transmits temperature data from either a thermocouple or RTD by way of a two-wire loop. The loop has an external power supply. The transmitter acts as a variable resistor with respect to its input signal. Transmitters are desirable when long lead or extension wires produce unacceptable signal degradation.

**U**

**Upscale Break Protection**

A form of break detection for burned-out thermocouples. Signals the operator that the thermocouple has burned out.

**Undershoot**

The amount by which a process variable falls below the setpoint before it stabilizes.

**V**

**Volt (V)**

The unit of measure for electrical potential, voltage or electromotive force (EMF).  
See Voltage.

**Voltage (V)**

The difference in electrical potential between two points in a circuit. It's the push or pressure behind current flow through a circuit. One volt (V) is the difference in potential required to move one coulomb of charge between two points in a circuit, consuming one joule of energy. In other words, one volt (V) is equal to one ampere of current (I) flowing through one ohm of resistance (R), or  $V=IR$ .

**Z**

**Zero Cross**

Action that provides output switching only at or near the zero-voltage crossing points of the ac sine wave.

